

INCLUSIVE. DURABLE. RELIABLE.



SIGNXPRESS INDIA

 www.signxpressindia.com

 info@signxpressindia.com

 RZ-8, Uttam Nagar East,
New Delhi - 110059. India.

INNOVATIVE & COLLABORATIVE

Signxpress India offers innovative accessible products, including Braille Signage and tactile tiles, designed to enhance inclusivity and accessibility for everyone.

SIGNXPRESS INDIA COMPANY PROFILE



Introduction:

SignXpress India is a leading provider of innovative and high-quality PU Tactile Tiles, Braille Signage, and Road Safety Products. With a commitment to accessibility, safety, and quality, we cater to diverse industries and sectors across India.

Our Products:

PU Tactile Tiles:

Our PU Tactile Tiles are designed to enhance accessibility for individuals with visual impairments. Crafted from durable polyurethane material, these tiles offer tactile guidance for safe navigation in public spaces, including sidewalks, pedestrian crossings, and train platforms.

Braille Signage:

We specialize in manufacturing Braille Signage that complies with accessibility standards, ensuring inclusivity for all. Our Braille Signage solutions include directional signs, information boards, and facility labels, featuring clear tactile and visual elements to aid navigation and communication.

Road Safety Products:

SignXpress India offers a comprehensive range of road safety products to improve traffic management and enhance road safety. From reflective road studs and traffic cones to barricades and delineators, our products prioritize safety and visibility on Indian roads.

Key Features:

Compliance: Our products adhere to relevant national and international standards, ensuring quality, reliability, and compliance with regulatory requirements.

Durability: Built to withstand harsh weather conditions and heavy usage, our products are durable and long-lasting, providing cost-effective solutions for various applications.

Innovation: We continuously innovate to address the evolving needs of our customers, incorporating advanced materials and technologies to enhance product performance and user experience.

Customization: Our flexible manufacturing capabilities enable us to offer customized solutions tailored to the specific requirements of our clients, ensuring maximum satisfaction and usability.

Industries Served:

Our products find applications across various industries and sectors, including:

- Transportation and Infrastructure
- Education and Healthcare Facilities
- Hospitality and Retail
- Government and Municipalities
- Construction and Real Estate

Clientele:

We are proud to have served a diverse clientele, including government agencies, corporate entities, educational institutions, and construction companies, among others. Our commitment to quality and customer satisfaction has earned us a reputation as a trusted partner in accessibility and road safety solutions.

SignXpress India

Conclusion:

At SignXpress India, we are dedicated to creating a more accessible, safe, and inclusive environment for all.

With our range of PU Tactile Tiles, Braille Signage, and Road Safety Products, we strive to make a positive impact on communities and contribute to building a better future for generations to come.

Enhance Accessibility, Elevate Inclusivity!



We make India an accessible & inclusive country for people with disability and make the public infrastructure more safer for everyone with Accessible & Road Safety Products.

At Signxpress India, we're committed to providing organizations of all sizes and types with quality interior signage and Road Safety Products. No matter what industry you're in, you can trust our team to help you with your next sign project and ensure the displays you order fit your unique needs.

Here are just some of the markets we serve:

- **Govt. & Private Projects** – We specialize in govt. and pvt. project execution excellence.
- **Sign Shops & Wholesale** – Become a wholesale partner or Braille signage reseller!
- **Contractor** – Take newly constructed and renovated buildings to the next level.
- **Elementary & High Schools** – Create an inclusive environment for all students.
- **Colleges & Universities** – Improve wayfinding and accessibility across campus.
- **Hotel** – Ensure the safety of guests while providing a welcoming atmosphere.
- **Apartment** – Develop a sense of community among residents in your complex.
- **Assisted Living** – Help make residents at your facility feel at home and at ease.
- **Health Care** – Simplify navigation for patients, new staff members, and visitors.
- **And more!**



OUR PRODUCTS

- ✓ Pu Tactile Tiles Self-Adhesive Tape
- ✓ Stainless Steel Tactile Tiles Self-Adhesive Tape
- ✓ Acrylic Braille Signage & Tactile Map
- ✓ Stainless Steel Braille Signage & Tactile Map
- ✓ Fire & Safety Signages
- ✓ Emergency Evacuation Plan Signage
- ✓ Q-Manager with Custom Logo
- ✓ Floor Marking Tape
- ✓ Malls, office, Showroom Signages
- ✓ Airport, Railway, Metro, Bus stop Signages
- ✓ Indoor & Outdoor Digital Window Poster
- ✓ Led Acrylic Letter Sign Board
- ✓ Parking & Warehouse Safety Products
- ✓ IRC & NHAI Road Safety Sign Board
- ✓ ABS Road Studs
- ✓ Aluminium Road Studs
- ✓ Solar Studs
- ✓ Flexible Median Marker
- ✓ Metal Delineator (customised)
- ✓ IRC Delineator
- ✓ Anti Glare Barricades
- ✓ Epoxy Adhesive
- ✓ Rubber Corner Guard
- ✓ Plastic Speed Breaker
- ✓ Rubber Speed Breaker
- ✓ Reflective Sign Board
- ✓ Solar Traffic Blinker
- ✓ Thermoplastic Road Marking



**ACCESSIBLE
INDIA
CAMPAIGN**

AN INCLUSIVE SOCIETY CREATES A
SASHAKT BHARAT



Scan and
Download
the PDF

Advantage of PU Tactile Tiles



It is a state-of-the-art design **ground surface indicator for the vision impaired and the differently-abled**. This unique product is a very new concept in India and **it is ideal for use both in indoor and outdoor applications to create a barrier-free environment**. These tiles can be installed in minutes by peel-and-bond technology, but still provide long lasting solution. It is being manufactured as per **CPWD & ISO 23599:2019** specifications.

MATERIAL

The Tactile is Manufactured from 100% Virgin Certified TPU Material.

QUALITY

PU TACTILE TILE-STRIP-STUD are manufactured in Approved Standard Guidelines. Used strong & High-Quality self-adhesive ensures perfect bonding.

INSTALLATION METHOD



PU Tactile can be installed on any smooth surface by just peel and bond method i.e. just peel off the back side sticker and fix the tile on the floor firmly. The alignment should be checked properly while installing the tiles and there should not be any gap left in between the adjacent tiles. **Prior to the installation, it is necessary to make the surface level smooth and in order by attending repairs if any so that fixing of PU Tactile may be ensured by the technical team at site.**



COMPARISON BETWEEN CERAMIC AND PU TACTILE

Ceramic Tactile	Polyurethane Tactile
Non self adhesive	Self Adhesive
Installation takes a lot of time	Installation is very quick
Color fades away	No color fading
Less color availability	Available in different colours
Feels hard	Feels soft
Prone to crack	Crack will not rise
Less friction	Very high friction
Low luminance contrast	High luminance contrast
Can be Installed only on chipped surface	Can be install on any surface metal, wooden, concrete, granite etc.

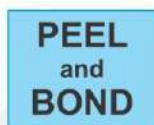

PRODUCT DATA

Parameters	Specifications
Dimensions	300 mm X 300 mm
Product weight	300 g Appx
ISO 23599-2019	Compliant
Materials	Polyurethane
UV Stability	Yes
Warranty	5 years
Life Expectancy	7-10 years
Indoor use	Yes
Outdoor use	Yes
Adhesive	Tissue or Butyl d/s tape

APPLICATIONS

(Under salient features of the rights of persons with disabilities act, 2016 section 40 to 46)

**RAMPS ● BUS STOPS ● CAR PARKS ● ZEBRA CROSSINGS ● RAILWAY PLATFORMS
ESCALATOR ENTRANCES ● SCHOOLS ● HOSPITALS ● OVERHEAD HAZARDS ● TOILET
STAIRWAYS ● SWIMMING POOL ● LIFT ENTRANCE ● DOOR ENTRANCE ● FIRE ESCAPES**

DISADVANTAGE OF CERAMIC TACTILE TILES



Prone to crack



Feels hard



Low luminance contrast



Less color availability



Color fades away



Can be Installed only on chipped surface



Installation takes a lot of time



Non self adhesive



PU TACTILE TILES STRIPS AND STUDS



ISO 23599 COMPLIANT

PU TACTILE TILE 101 TT

PU Tactile Tile with Self-adhesive Tissue Tape

TISSUE TAPE HIGH BOND TAPE

TISSUE TAPE BEST FOR INDOOR

ONLY FOR DRY & SMOOTH SURFACES
STONE, TIMBER, VITRIFIED, GLASS

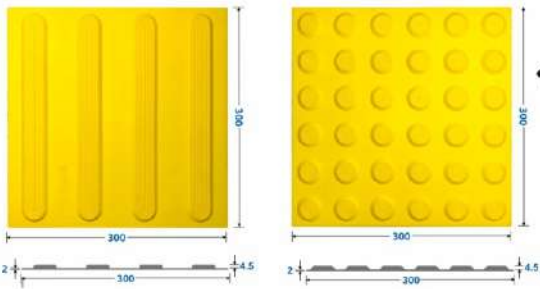

- Dimensions : 300 x 300 x 7 mm
- Raw Material : Polyurethane UV Stabilized & Stain Resistant
- Tile Pattern : Anti-skid Concentric / Linear Pattern
- Self-adhesive Tape : 140µ Tissue Tape
- Suitable Substrates : Stone / Masonry / Timber / Vitrified / Glass / Metals
- Fixing : Peel & Paste (No Civil Work required)



Peel & Paste

PU TACTILE TILE 101 BT

PU Tactile Tile with Strong Butyl Tape +Washer and Screw

BUTYL TAPE SCREW

BUTYL TAPE+ SCREW BEST FOR OUTDOOR

DRILL & FIXED GETS STRONG FIXING
DRY SURFACES
RCC, KOTA, CEMENT

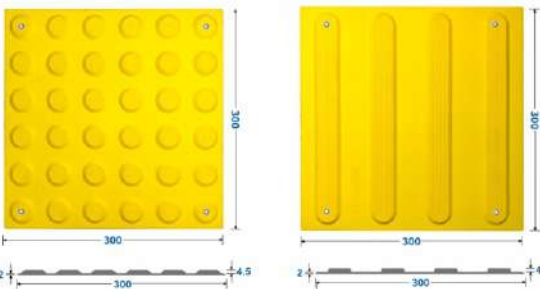

- Dimensions : 300 x 300 x 7 mm
- Raw Material : Polyurethane UV Stabilized & Stain Resistant
- Tile Pattern : Anti-skid Concentric / Linear Pattern
- Self-adhesive Tape : 1mm Butyl Rubber Tape
- Suitable Substrates : Stone / Masonry / Timber / Vitrified / Glass / Metals
- Fixing : Peel & Paste (No Civil Work required)



Peel & Paste

ABS TACTILE TILE 101 ABS

ABS Tactile Tile

**ABS TACTILE
NEVER CRACKED
NEVER COLOR FADE
100% COMPLIANCE**

ABS TACTILE BEST FOR PATHWAY

FILLED WITH CONCRETE
PAVER BLOCKS, RCC-BITUMEN ROADS
FOR STRONG LONG LASTING RESULT

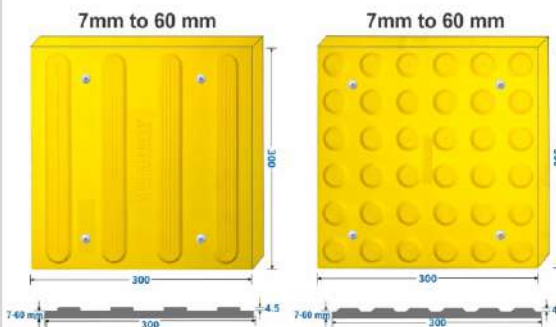

- Dimensions : 300 x 300 x 7-60 mm
- Raw Material : UV Stabilized & Stain Resistant
- Tile Pattern : Anti-skid Concentric / Linear Pattern
- Suitable Substrates : Paver Blocks, Bitumen Road, RCC Roads
- Fixing : Filled With Cement, Concrete Mixture

REPLACE WITH
EXCITING
CERAMIC TILES

NEW ARRIVAL

PU TACTILE TILES SELF-ADHESIVE BY SIGNXPRESS INDIA



ITC GREEN CENTRE



NAMO METRO



SEWA KENDRA - TIS HAZARI COURT



CPWD - RK PURAM



AMBIANCE SCHOOL



DSIIDC HEAD OFFICE



POST OFFICE - TAMIL NADU



KEY FEATURES

- Strong Impact and Abrasion Resistance
- High UV Stability Ensures Stand up to India's Harsh Climate
- Solution for Slippery Surface
- Polyurethane Made Tactile Tiles Ensure long durability
- DIY Peel and Paste / Bond Installation
- Available in Both Hazard (Button) and Directional (Rib) Profiles
- Strong Butyl Rubber Adhesive Resists Movement.



PU TACTILE TILES STRIPS AND STUDS



PU TACTILE TILE 102 STM

STEM

PUT-STRP-B (4 STEM)

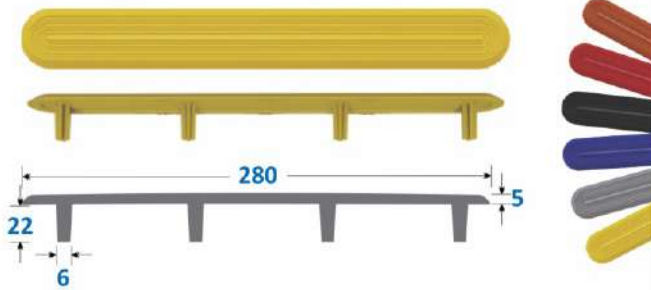

- Dimensions : 280 x 35 x 5 mm / Stem 22 mm
- Raw Material : Polyurethane UV Stabilized & Stain Resistant
- Self-adhesive : 140µ Tissue Tape / 4 Stems
- Strip Pattern : Strip with Anti-skid Linear Pattern
- Suitable Substrates : Stone / Masonry / Timber / Vitrified / Glass / Metals
- Fixing : Peel & Paste (No Civil Work required) / 4 Stems drill & fix

PU TACTILE TILE 102 SA

SELF-ADHESIVE

PUT-STRP-A (TISSUE)

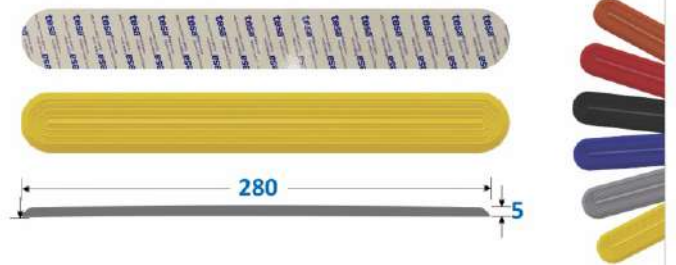

- Dimensions : 280 x 35 x 5 mm / Stem 22 mm
- Raw Material : Polyurethane UV Stabilized & Stain Resistant
- Self-adhesive : 140µ Tissue Tape / 4 Stems
- Strip Pattern : Strip with Anti-skid Linear Pattern
- Suitable Substrates : Stone / Masonry / Timber / Vitrified / Glass / Metals
- Fixing : Peel & Paste (No Civil Work required) / 4 Stems drill & fix

PU TACTILE STUD 103 STM

STEM

PUT-STD-B (STEM)

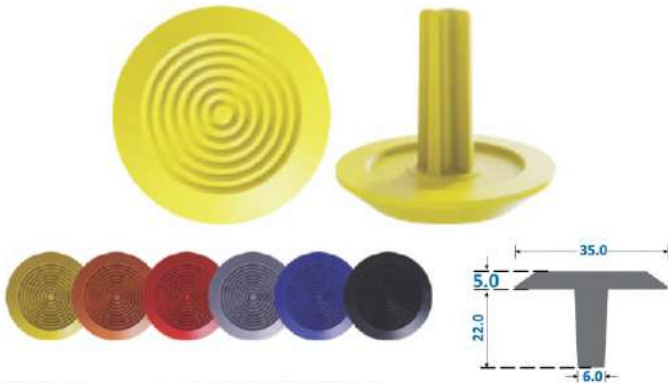

- Dimensions : 35 x 5 mm / Stem 22 mm
- Raw Material : Polyurethane UV Stabilized & Stain Resistant
- Self-adhesive : 140µ Tissue Tape / 1 Stems
- Stud Pattern : Stud with Anti-skid Concentric Rings Pattern
- Suitable Substrates : Stone / Masonry / Timber / Vitrified / Glass / Metals
- Fixing : Peel & Paste (No Civil Work required) / 1 Stem drill & fix

PU TACTILE STUD 103 SA

SELF-ADHESIVE

PUT-STD-A (TISSUE)



- Dimensions : 35 x 5 mm / Stem 22 mm
- Raw Material : Polyurethane UV Stabilized & Stain Resistant
- Self-adhesive : 140µ Tissue Tape / 1 Stems
- Stud Pattern : Stud with Anti-skid Concentric Rings Pattern
- Suitable Substrates : Stone / Masonry / Timber / Vitrified / Glass / Metals
- Fixing : Peel & Paste (No Civil Work required) / 1 Stem drill & fix



- SCHOOLS
- OFFICES
- HOTELS
- HOSPITALS



NEW ARRIVAL

PU TACTILE TILES SELF-ADHESIVE BY SIGNXPRESS INDIA



MINISTRY OF SOCIAL JUSTICE & EMPOWERMENT



IIT DELHI



DELHI GOVT DISPENSARY DWARKA-14



DELHI GOVT DISPENSARY DWARKA-19



BHUTAN TRUST FUND FOR ENVCONSERVATION



BR SUR HOSPITAL



REVENUE DEPT. LUCKNOW





SS TACTILE TILES STRIPS AND STUDS



SS TACTILE TILE 104 SLD

#SOLID

Premium Quality Heavy Duty

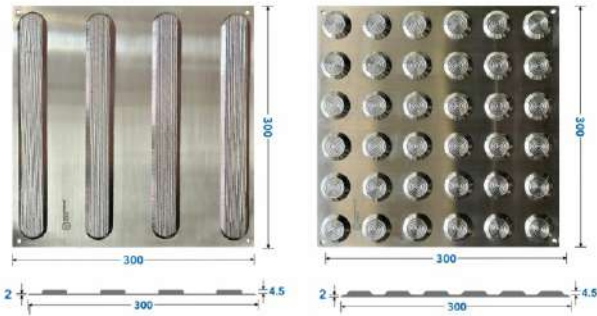

Dimensions : 300 x 300 x 2 mm
 Raw Material : Stainless Steel 304 & 316 Grade
 Tile Pattern : Anti-skid Concentric / Linear Pattern
 Suitable Substrates : Stone / Masonry / Timber / Vitrified / Glass / Metals
 Fixing : Drill and Screw

SS TACTILE TILE 104 SHT

#SHEET

Affordable Light Weight

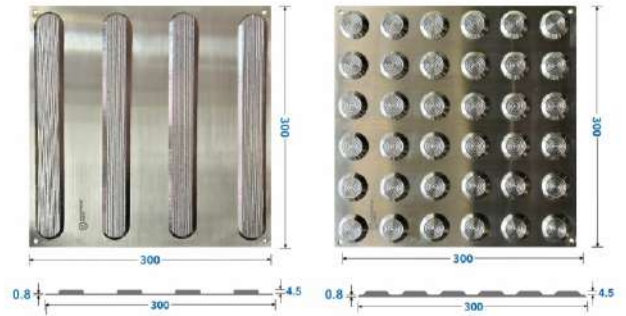

Dimensions : 300 x 300 x 0.8 mm
 Raw Material : Stainless Steel 304 & 316 Grade
 Tile Pattern : Anti-skid Concentric / Linear Pattern
 Suitable Substrates : Stone / Masonry / Timber / Vitrified / Glass / Metals
 Fixing : Drill and Screw

SS TACTILE STRIP 105 SLD

#SOLID

Premium Quality Heavy Duty



Dimensions : 280 x 35 x 4.5 mm / Stem 12 mm
 Self-adhesive : 3M VHB Tape / 3 Stems
 Strip Pattern : Strip with Anti-skid Linear Pattern
 Suitable Substrates : Stone / Masonry / Timber / Vitrified / Glass / Metals
 Fixing : Peel & Paste (No Civil Work required) / 3 Stems drill & fix

SS TACTILE STRIP 105 SHT

#SHEET

Affordable Light Weight



Dimensions : 280 x 35 x 4.5 mm / Stem 12 mm
 Self-adhesive : 3M VHB Tape / 3 Stems
 Strip Pattern : Strip with Anti-skid Linear Pattern
 Suitable Substrates : Stone / Masonry / Timber / Vitrified / Glass / Metals
 Fixing : Peel & Paste (No Civil Work required) / 3 Stems drill & fix

PU TACTILE STUD 106 SLD

#SOLID



Dimensions : 35 x 4.5 mm / Stem 12 mm
 Self-adhesive : 3M VHB Tape / 1 Stems
 Tile Pattern : Stud with Anti-skid Concentric Rings Pattern
 Suitable Substrates : Stone / Masonry / Timber / Vitrified / Glass / Metals
 Fixing : Peel & Paste (No Civil Work required) / 1 Stem drill & fix

PU TACTILE STUD 106 SHT

#SHEET

Filled With Epoxy Hardener



Dimensions : 35 x 4.5 mm / Stem 12 mm
 Self-adhesive : 3M VHB Tape / 1 Stems
 Tile Pattern : Stud with Anti-skid Concentric Rings Pattern
 Suitable Substrates : Stone / Masonry / Timber / Vitrified / Glass / Metals
 Fixing : Peel & Paste (No Civil Work required) / 1 Stem drill & fix

**NEW
ARRIVAL**

SS TACTILE TILES SELF-ADHESIVE BY SIGNXPRESS INDIA



Stainless Steel Tactile Indicators SS 304 & SS 316 Grade

by Signxpress India



Model No.: SIGB 01

Straight Grab Bar



Material	SS-304 Grade
Dimensions	600 x 32 mm
Application	WC Area
Size	600 mm
Fixing	Drill & Fix with Screw

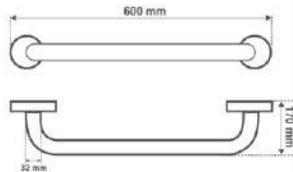

Model No.: SIGB 02

Swing Grab Bar



Material	SS-304 Grade
Dimensions	750 x 215 x 300 x 100 mm
Application	WC Area
Size	750 mm
Fixing	Drill & Fix with Screw

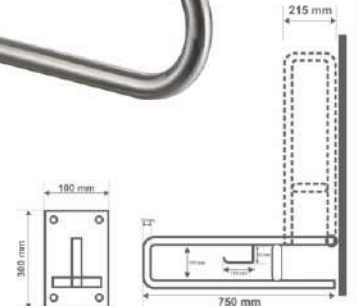

Model No.: SIGB 03

U-Shaped Grab Bar



Material	SS-304 Grade
Dimensions	800 x 215 mm
Application	WC Area
Size	800 mm
Fixing	Drill & Fix with Screw

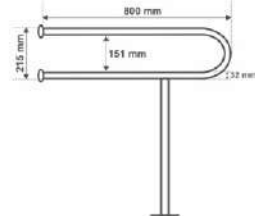

Model No.: SIGB 04

L Shaped Grab Bar



Material	SS-304 Grade
Dimensions	600 x 600 mm
Application	WC Area
Size	600 mm
Fixing	Drill & Fix with Screw

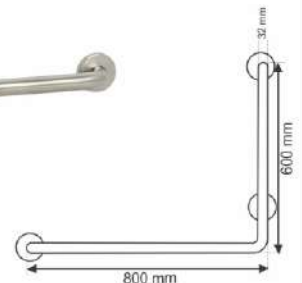

Model No.: SIGB 05

Urinal Safety Steel Grab Bar

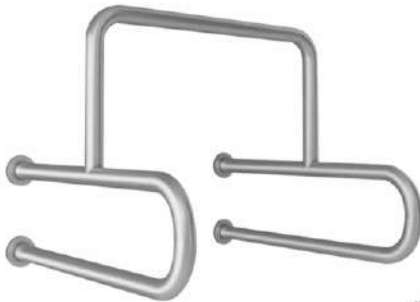

Material	SS-304 Grade
Dimensions	600 x 32 mm
Application	Urinal Area
Size	600 mm
Fixing	Drill & Fix with Screw

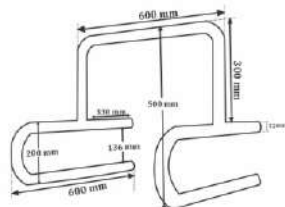

Signxpress India's Stainless Steel Grab Bar offers sturdy support and safety in various settings. Crafted from durable stainless steel, it ensures reliability and longevity, ideal for bathrooms, hospitals, and public facilities.

ACRYLIC BRAILLE SIGNAGE 107



BRL-SIGN-ACR-107



- Specifications : Base: 4 mm Letters: 1 mm
- Raw Material : A-cast Matt Finish Acrylic Sheet
- Standard Sizes : 150x230, 200x200, 450x450 (mm) & customized
- Braille Dots : 1.5 mm SS 304 Grade
- Fixing : Peel & Paste / Screw
- Colours Available : 

STAINLESS STEEL BRAILLE SIGNAGE 108



BRL-SIGN-SS-108



- Specifications : 0.5 mm 304 Grade Matt Finish
- Standard Sizes : 150x230, 200x200, 450x450 (mm) & customized
- Braille Dots : 1.5 mm SS 304 Grade
- Fixing : Peel & Paste / Screw
- Colours Available : 

ITC PAPERBOARD BRAILLE SIGNAGE 109



BRL-SIGN-ITC-109



- Specifications : Base: 3 mm Letters: 2 mm
- Raw Material : Matt Finish Paper Board
- Standard Sizes : 150x230, 200x200, 450x450 (mm) & customized
- Braille Dots : 1.5 mm SS 304 Grade
- Fixing : Peel & Paste / Screw
- Colours Available : 

WOODEN BRAILLE SIGNAGE 110



BRL-SIGN-MDF-110



- Specifications : Base: 3 mm Letters: 3 mm
- Raw Material : Mdf Laminated
- Standard Sizes : 150x230, 200x200, 450x450 (mm) & customized
- Braille Dots : 1.5 mm SS 304 Grade
- Fixing : Peel & Paste / Screw
- Colours Available : 

SS RAILING SIGNAGE 111



BRL-SS-RLNG-111



- Specifications : 0.5 mm 304 Grade Matt Finish
- Standard Sizes : 200x50 (mm) & customized
- Braille Dots : 1.5 mm SS 304 Grade
- Fixing : Peel & Paste / Screw
- Colours Available : 

TACTILE MAP - ACRYLIC BRAILLE SIGNAGE 112



BRL-SIGN-TMAP-112



- Specifications : Base: 4 mm Letters: 1 mm
- Raw Material : A-cast Matt Finish Acrylic Sheet
- Standard Sizes : 48x36 inch & customized
- Braille Dots : 1.5 mm SS 304 Grade
- Fixing : Peel & Paste / Screw
- Colours Available : 



ATM BRAILLE BUTTON & SIGNAGES

NEW ARRIVAL

ATM BRAILLE BUTTONS 113

BRL-SIGN-SS-ATM-113

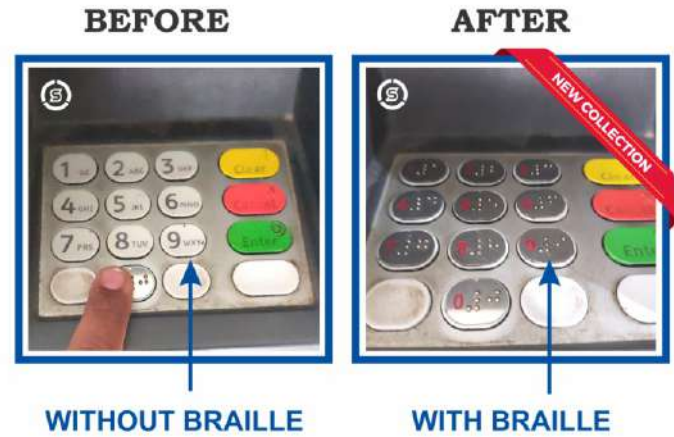

- Specifications : 0.5 mm 304 Grade Matt Finish
- Standard Sizes : 20X15 (mm) & customized
- Braille Dots : 1.5 mm SS 304 Grade
- Fixing : Peel & Paste
- Colours Available :

EMERGENCY BRAILLE BELL 114

BLR-SIGN-BELL-114

EMERGENCY BELL CORDLESS



EMERGENCY BELL CORDLESS



PUSH BUTTON TALKING BRAILLE SIGNAGE



ANNOUNCEMENT SIGNAGE



TALKING TACTILE MAP 115

BRL-SIGN-TALK-MAP-115



- Dimensions : 48x36 inch (Customize)
- Material : Acrylic
- Base : 4mm
- Power Supply : AC/DC



Explore the world through fingertips

Getting the custom interior **BRILLE SIGNS** you need is simple. We apply a 3-step process that streamlines your order while ensuring you're involved from start to finish.

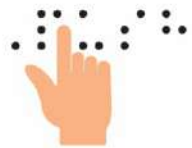

Quality and Compliant Signage with a Speedy Turnaround

- Quick Ship Signs Available for Shipping in Pan India
- Orders of less than 15 signs 1-2 business days
- 15 to 40 signs 3-4 business days
- Over 40 signs 5 business days
- Free Shipping Delhi/NCR only



BRILLE LIFT BUTTONS 116

BRL-SIGN-SS-LIFT-116

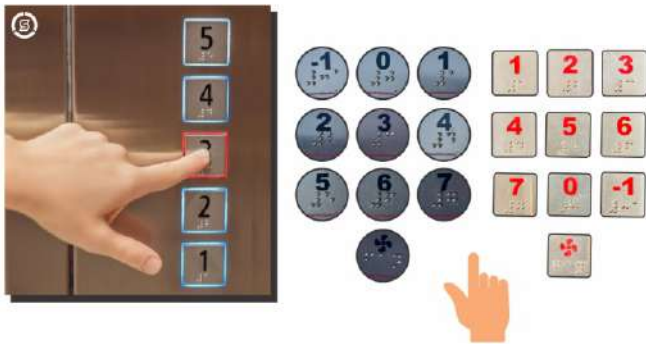

- Specifications : 0.5 mm 304 Grade Matt Finish
- Standard Sizes : 20X20 (mm) & customized
- Braille Dots : 1.5 mm SS 304 Grade
- Fixing : Peel & Paste
- Colours Available : 



BRILLE PUSH PULL 117

BRL-SIGN-SS-PP-117



- Specifications : 0.5 mm 304 Grade Matt Finish
- Standard Sizes : 6X2 inch & customized
- Braille Dots : 1.5 mm SS 304 Grade
- Fixing : Peel & Paste
- Colours Available : 



BRILLE TAP BUTTONS 118

BRL-SIGN-SS-TAP-118



- Specifications : 0.5 mm 304 Grade Matt Finish
- Standard Sizes : Customized
- Braille Dots : 1.5 mm SS 304 Grade
- Fixing : Peel & Paste
- Colours Available : 



WATER DISPENSER BUTTONS 119

BRL-SIGN-SS-RO-119

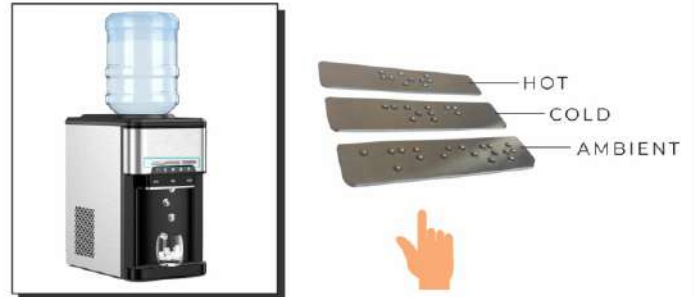

- Specifications : 0.5 mm 304 Grade Matt Finish
- Standard Sizes : Customized
- Braille Dots : 1.5 mm SS 304 Grade
- Fixing : Peel & Paste
- Colours Available : 

















NEW ARRIVAL

BRaille SIGNAGE BY SIGNXPRESS INDIA



If your building is open to the public, you must comply with braille signage and make the building accessible friendly for person with disability.
(Under salient features of the rights of persons with disabilities act, 2016 section 40 to 46)

Did You Know?

<p>BRAILLE SIGN 120</p> <p>BRL-SIGN-120</p> 	<p>BRAILLE SIGN 121</p> <p>BRL-SIGN-121</p> 	<p>BRAILLE SIGN 122</p> <p>BRL-SIGN-122</p> 	<p>BRAILLE SIGN 123</p> <p>BRL-SIGN-123</p> 
<p>BRAILLE SIGN 124</p> <p>BRL-SIGN-124</p> 	<p>BRAILLE SIGN 125</p> <p>BRL-SIGN-125</p> 	<p>BRAILLE SIGN 126</p> <p>BRL-SIGN-126</p> 	<p>BRAILLE SIGN 127</p> <p>BRL-SIGN-127</p> 
<p>BRAILLE SIGN 128</p> <p>BRL-SIGN-128</p> 	<p>BRAILLE SIGN 129</p> <p>BRL-SIGN-129</p> 	<p>BRAILLE SIGN 130</p> <p>BRL-SIGN-130</p> 	<p>BRAILLE SIGN 131</p> <p>BRL-SIGN-131</p> 
<p>BRAILLE SIGN 132</p> <p>BRL-SIGN-132</p> 	<p>BRAILLE SIGN 133</p> <p>BRL-SIGN-133</p> 	<p>BRAILLE SIGN 134</p> <p>BRL-SIGN-134</p> 	<p>BRAILLE SIGN 135</p> <p>BRL-SIGN-135</p> 



OUR CLIENTS & PROJECTS

PU TACTILE TILES AND BRAILLE SIGNAGE

- **NAMO BHARAT RAIL**
- **IIT - INDIAN INSTITUTE OF TECHNOLOGY**
- **IIT - KHARAGPUR**
- **DSIIDC OFFICES**
- **PWD GUEST HOUSE - REWARI, HR**
- **PWD SCHOOLS - DELHI**
- **PWD HOSPITALS - DELHI**
- **CPWD RESIDENTIAL COLONY**
- **COMMISSIONER OFFICE - GOA**
- **POST OFFICE - TAMILNADU**
- **ESIC HOSPITAL - BIHAR**
- **GOVT. HOSPITALS - DELHI**
- **BUS STOPS - GUJARAT**
- **NDMC TOILET - NEW DELHI**
- **CPWD - VIGYAN BHAWAN**
- **BLIND SCHOOL - DELHI**
- **SBI BANK - ARUNANCHAL PRADESH**
- **CIRCUIT HOUSE - ARUNANCHAL PRADESH**
- **GURU TEG BAHADUR UNIVERSITY**
- **NATIONAL HOMEOPATHY**



भारत सरकार Government of India
राष्ट्रीय परीक्षण शाला (उ.क्षे.)
National Test House (NR)
राष्ट्रीय परीक्षण शाला (उ.क्षे.), कमला नेहरू नगर, गाज़ियाबाद, उत्तर प्रदेश – 201002
Kamla Nehru Nagar, Ghaziabad, Uttar Pradesh - 201002



PART A. PARTICULARS OF SAMPLE SUBMITTED

COMPLETE TEST REPORT

भाग 'अ' जमा किये गये नमूने का विवरण

परीक्षण प्रमाणपत्र सं/Test Certificate No:
NTH(NR)/RPPT/22/1688_1

SRF Number:
NTH(NR)/RPPT/22/1688

जारी होने की तिथि/Date of issue
30 Dec, 2022

कोड सं/QR Code/Barcode
: NTH220013819

a) जिसे जारी करना है/Issued To	:	SIGNXPRESS INDIA
b) पता/Address	:	C-30, MILAP NAGAR, UTTAM NAGAR EAST, OPP. BANK OF BARODA, DELHI, West, Delhi, India - 110059
c) ग्राहक का संदर्भ सं एवं दिनांक/Customer's Ref. No.	:	No. PUT/ GZB-Testing/101-2022
d) नमूना मुहरबंद स्थिति/Sample Sealed Status	:	Not Sealed
e) परीक्षण सामग्री का विवरण/Description of Test item	:	Make Customized Designs, Patterns, and Colours applicable.
f) नमूना का विशिष्टता (यदि हो)/Product Specification(if any)	:	NTH/NR/RPPT/PU-Tile (2022) - Polyurethane Tactile Tile
g) नमूना प्राप्ति की तिथि /Date of Receipt of the Test item	:	16 Dec, 2022
h) कार्य सम्पादन की तिथि/Date(s)of Performance of Tests	:	From: 28 Dec, 2022 To: 30 Dec, 2022
i) Quantity	:	2.0 no
j) Any other Information / Expiry Date, If any	:	
k) Section Code	:	22RPDF00N
l) Section Report No.	:	22RPDF00N_1
m) Report Type	:	New
n) Reference Report No.	:	
o) Remarks	:	Test report forward as received.

Suresh Parwal
OIC SAMPLE CELL
(Authorized Signatory)
Authorized on: 30 Dec, 2022 12:54 PM

This is a Computer Generated Report.



**TESTED BY NATIONAL
TEST HOUSE**



सत्यमेव जयते

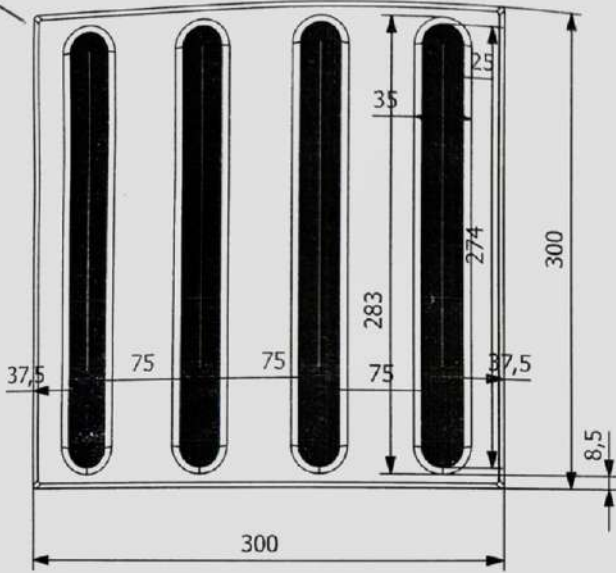

Section Code : 22RPDF00N

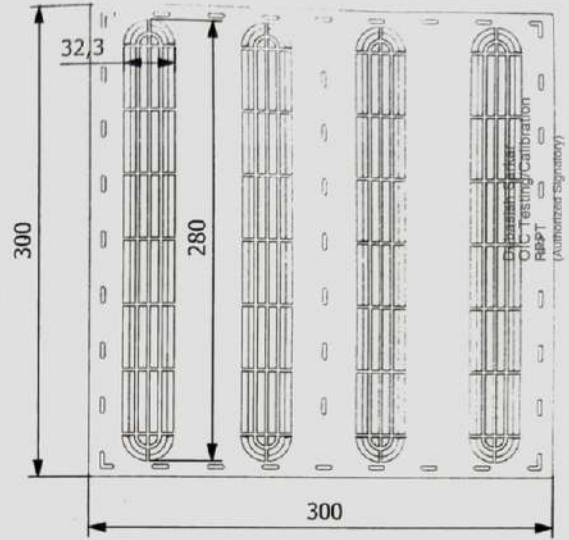
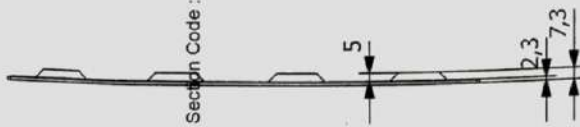

All Demension Are In MM

Handwritten signatures and dates
देबाशिस सार्कार / DEBASISH SARKAR
 वैज्ञानिक सी. (आर.सी.ई.) / Scientist C (RPT)
 राष्ट्रीय मीमांसा कक्षा (ए.ई.) / National Test House (RPT)
 एन.के.एस. बॉम्बे / N.K.S. Mumbai
 OIC Testing/Calibration
 RPPT
 (Authorized Signatory)

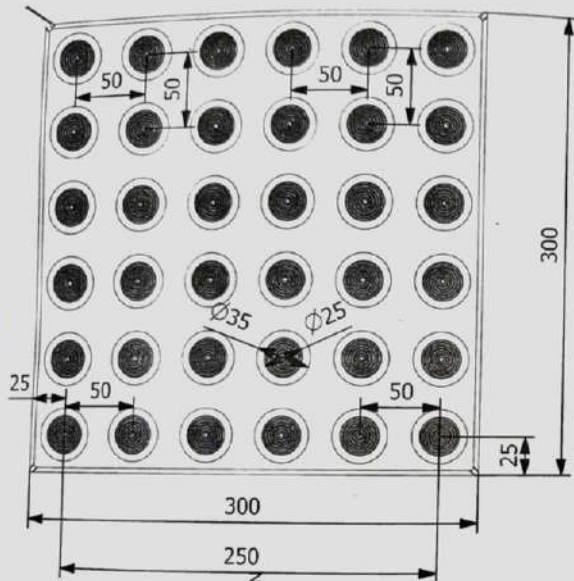

Section Code : 22RP1A5FN

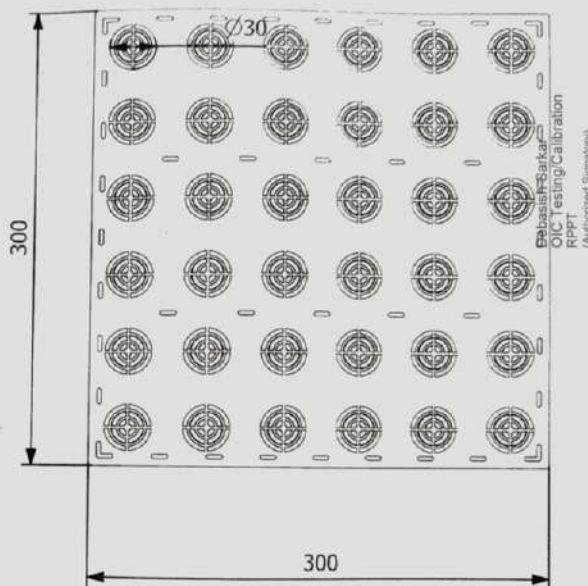

All Demension Are In MM

Handwritten signatures and dates
देबाशिस सार्कार / DEBASISH SARKAR
 वैज्ञानिक सी. (आर.सी.ई.) / Scientist C (RPT)
 राष्ट्रीय मीमांसा कक्षा (ए.ई.) / National Test House (RPT)
 एन.के.एस. बॉम्बे / N.K.S. Mumbai
 OIC Testing/Calibration
 RPPT
 (Authorized Signatory)



75
Azadi Ka
Amrit Mahotsav

दिल्ली सरकार
प्रमुख अभियंता, लो0नि0वि0,
12वां तल, बहु-मंजिला भवन, इंद्रप्रस्थ संपदा, नई दिल्ली:110002
☎ 23490093, फैक्स23766924



Toll Free Complaint No. 1800 11 0093

वेबसाइट: <http://pwd.delhigovt.nic.in>

ई-मेल: dirw-pwd@delhi.gov.in

No.E-in-C/PWD/Works/2023/NMET./ 3137

Dated: .05.2023

25

OFFICE MEMORANDUM

Subject: Approval of Preferred make/brand name of M/s SIGNXPRESS INDIA.

Approval of Competent Authority is hereby conveyed to incorporate the make/brand mentioned below in the list of approved make of future NIT's of PWD works.

S. No.	Description of items.	Brand of Product.
1.	PU Tactile Tiles (Warning & Direction)	M/s SIGNXPRESS INDIA.
2.	PU Tactile Strips with Stem (Direction).	
3.	PU Tactile Stud with Stem (Warning).	
4.	Acrylic Braille Signage.	
5.	Stainless Steel Braille Signage.	
6.	Stainless Steel Strip.	
7.	Stainless Steel Stud.	

1.) This approval is for a period of **two years** from the date of issue of this office memorandum and will automatically lapse at the end of this period.

2.) CE's, SE's, EE's & AE's are required to incorporate the above brand along with the already approved other brands in the "List of Preferred Makes" in the NIT's to be approved by them.

3.) While specifying different brands of a product the CVC guidelines regarding quality and price of equivalent brands must be followed.

4.) This approval does not absolve the Executive/Supervisory officers concerned of their responsibility of exercising necessary checks like quality, rates & performance of the product while processing/using the same. Shortcoming/deficiencies, if observed while in use at site shall be brought to the notice of this office.

5.) This approval does not make the firm eligible for claiming the right to get the work done or items procured through them only. Work/ Procurement is subject to



firm's competitive offers against other competing manufactures/Brands/Suppliers as mentioned in NIT.

6.) The performance of the firms shall be watched by field units and report shall be submitted for periodical review.

This issues with the approval of Engineer-in-Chief, PWD GNCTD.

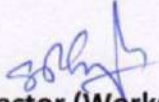

Dy. Director (Works)
PWD, GNCTD.

Copy To:

1. Pr. C.E. (Project), 9th floor MSO Building, IP Estate, New Delhi.
2. Pr. C.E. (M&F), 12th floor MSO Building, IP Estate, New Delhi.
3. CE (East), 3rd floor MSO Building, IP Estate, New Delhi.
4. CE (North), 5th floor MSO Building, IP Estate, New Delhi.
5. CE (South), 7th floor MSO Building, IP Estate, New Delhi.
6. CE (Flyover), 4th floor MSO Building, IP Estate, New Delhi.
7. CE (Health), 2nd floor MSO Building, IP Estate, New Delhi.
8. CE (Projects), 1st floor MSO Building, IP Estate, New Delhi.
9. CE (O.P.), 13th floor MSO Building, IP Estate, New Delhi.
10. Mr. Honey Chugh, CEO & MD (Technical) C-30, Milap Nagar, Uttam Nagar East, New Delhi-110059. India (M) 9810032137, (E) info@signxpressindia.com.

HONEY CHUGH
CEO, MD TECHNICAL

9810032137

25/5/2023

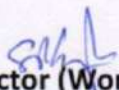
Dy. Director (Works)
PWD, GNCTD.





Delhi State Industrial and
Infrastructure Development
Corporation Ltd.
A Government Undertaking

N-36, Bombay Life Building
Connaught Circus
New Delhi - 110 001, India

Regd. Office :
A-3/4, State Emporia Building,
Baba Khark Singh Marg, New Delhi-110001

T : +91 11 2331 4231-34
F : +91 11 2371 0666
E : support@dsiidc.org
www.dsiidc.org

No. DSIIDC/EE/2024-2025/736

Date :- 04.01.2024

Subject: Approval of Preferred make/brand name of M/s SIGNXPRESS INDIA

Approval of competent Authority is hereby conveyed to incorporate the make/brand mentioned below in the list of approved make of future NIT's of DSIIDC works.

S. No.	Description of items.	Brand of Product.
1	PU Tactile Tiles (Warning & Direction)	M/s SIGNXPRESS INDIA
2	PU Tactile Strip with Stem/Self-adhesive (Direction)	M/s SIGNXPRESS INDIA
3	PU Tactile Stud with Stem/Self-adhesive (Warning)	M/s SIGNXPRESS INDIA
4	Acrylic Braille Signage	M/s SIGNXPRESS INDIA
5	Stainless Steel Braille Signage	M/s SIGNXPRESS INDIA
6	Stainless Steel Tactile Strip	M/s SIGNXPRESS INDIA
7	Stainless Steel Tactile Stud	M/s SIGNXPRESS INDIA

1. This approval is for a period of Five Years from the date of issue of this letter.
2. All Engineers are required to incorporate the above brand along with the already approved other brands in the "List of Preferred Makes" in the NIT's to be approved by them.

The issue with the approval of Engineer-in-chief, DSIIDC - Delhi State Industrial and infrastructure Development Corporation

Executive Engineer(Maint.)





भूमि कल्पना
ONE VISION - ONE TARGET - ONE FUTURE

भारत सरकार
GOVERNMENT OF INDIA
केन्द्रीय लोक निर्माण विभाग
CENTRAL PUBLIC WORKS DEPARTMENT



कार्यालय-कार्यपालक अभियन्ता
राजमनोहरी मंडल, को लो नि वि
नई दिल्ली-110001,
दूरभाष :23365663,23345291/ फैक्स:23365663
ई-मेल : delectrmlh.cpwd@nic.in

Office of Executive Engineer
RML Division, C.P.W.D.
New Delhi-110001
PH No. 23365663, 23345291/ Fax : 23365663
E-Mail- delectrmlh.cpwd@nic.in

पत्र सं०:-26(1)/योजना शाखा/राजमनोहरी/2024-25/1180

दिनांक: 29/08/2024

PERFORMANCE CERTIFICATE

To,

Signxpress India
RZ-8, Uttam Nagar East
New Delhi-110059

Sub: Work Completion and Appreciation for Signxpress India's Excellent PU Tactile, & Braille Signage services at Ram Manohar Lohia, OPD (CPWD)

I am writing to express a heartfelt appreciation for the exceptional products and services provided by Signxpress India work at Ram Manohar Lohia, OPD (CPWD).

Signxpress India, as the manufacture responsible for supplying PU Tactile Tiles and Braille Signage, has exceeded our expectations in every aspect of this project. Their commitment to quality, attention to detail, and dedication to meeting project deadlines have been exemplary. The PU Tactile Tiles and Braille Signage supplied by Signxpress India have not only met but also surpassed the highest standards of quality and durability. These products have significantly enhanced the accessibility and safety of the public infrastructure within our jurisdiction, aligning perfectly with our mission of creating inclusive environments.

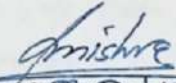
Executive Engineer
RML Division
CPWD, New Delhi



CPWD



PWD Delhi

PUBLIC WORKS DEPARTMENT

Ref. No. 2(01)/JE/SE(B)M/SLC/2023-24/

Dated:14.02.2024

PERFORMANCE CERTIFICATE

To,

Signxpress India
RZ-8, Uttam Nagar East
New Delhi-110059

Sub: Work Completion and Appreciation for Signxpress India's Excellent Products

I am writing to express my heartfelt appreciation for the exceptional products and services provided by Signxpress India work at GGSSS No. 3, Badarpur.

Signxpress India, as the manufacture responsible for supplying PU Tactile Tiles and Braille Signage, has exceeded our expectations in every aspect of this project. Their commitment to quality, attention to detail, and dedication to meeting project deadlines have been exemplary. The PU Tactile Tiles and Braille Signage supplied by Signxpress India have not only met but also surpassed the highest standards of quality and durability. These products have significantly enhanced the accessibility and safety of the public infrastructure within our jurisdiction, aligning perfectly with our mission of creating inclusive environments.

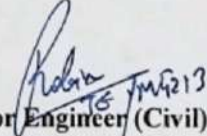
Junior Engineer (Civil)

Sub-Division-III, SE(B)M PWD
Sunlight Colony, New Delhi.

Junior Engineer (C)
Enquiry Office, PWD
Sunlight Colony, New Delhi





༄ | ཨིན་གཤམ་རྒྱལ་ལས་གཞི་ལྷན་ཁུངས་ལེ་སྐོར་ལེ་སྐོར་།
T & K CONSTRUCTION PRIVATE LIMITED
Experienced in Road and Building Construction with Traditional Architecture.

Appreciation Letter

Sub: Work Completion and Appreciation for Signxpress India's Excellent Products and Services at Construction of Bhutan Trust Fund For Environmental Conservation

Dear Mr. Honey Chugh,

I am writing to express my heartfelt appreciation for the exceptional products and services provided by Signxpress India during our recent project for BTFEC at Thimphu, Bhutan with the T&K Construction pvt. Ltd. under the Finance department.

Signxpress India, as the manufacture responsible for supplying PU Tactile Tiles and Braille Signage, has exceeded our expectations in every aspect of this project. Their commitment to quality, attention to detail, and dedication to meeting project deadlines have been exemplary. The PU Tactile Tiles and Braille Signage supplied by Signxpress India have not only met but also surpassed the highest standards of quality and durability. These products have significantly enhanced the accessibility and safety of the public infrastructure within our jurisdiction, aligning perfectly with our mission of creating inclusive environments.

Key points of appreciation include:

Product Excellence: Signxpress India's PU Tactile Tiles and Braille Signage have demonstrated exceptional quality, complying with all relevant standards and regulations.

Timely Completion: The project was executed with remarkable efficiency, meeting all project milestones and deadlines.

Professionalism: The Signxpress India team exhibited professionalism, responsiveness, and a strong commitment to customer satisfaction throughout the project.

Innovation: Their products reflect cutting-edge innovation in the field of accessibility, making a significant impact on public infrastructure.

We believe that Signxpress India's contributions have not only improved the physical landscape of our region but have also enriched the lives of our citizens by providing safer and more accessible public spaces.

On behalf of the T&K Construction private limited under the finance department, I would like to extend our sincere gratitude to Signxpress India for their outstanding work. We look forward to the possibility of collaborating on future projects and further enhancing the accessibility and inclusivity of our public infrastructure.

Please convey our appreciation and recognition to the entire Signxpress India team for their dedication and commitment to excellence.

Thank you once again for the outstanding products and services provided by Signxpress India.

Sincerely,

Jigme Ugyen Gyamtsho
Director-Finance
21/11/2023

**OFFICE OF THE EXECUTIVE ENGINEER (SD)
NEW DELHI MUNICIPAL COUNCIL
2ND FLOOR ROOM NO 2001-C
PALIKA KENDRA, NEW DELHI**

No. D/ 495 /EE(SD)/2023

Date 05/12/23

M/s Signxpress India.
RZ-8, Mahindra park Uttam Nagar east
New Delhi-110059

Sub: - The request for Free sample disabled friendly Signage and Self-adhesive PU Tactile Tiles in NDMC Public Toilets at Hanuman Mandir New Delhi, Location Code CTU 03-005.

This is with reference to your letter dated 04.10.2023 regarding high-quality accessibility signage solutions by providing Braille signage and Self-adhesive PU Tactile Tiles. You are requested to install as samples of Braille signage and PU tiles signage at CTU 03-005 NDMC Toilets at Hanuman Mandir, New Delhi Location on free of cost for actual evaluation of the performance at the site. It shall be ensured that there shall not be damage to original finishing.

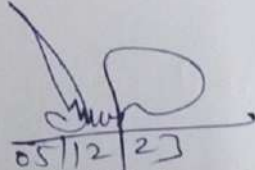
05/12/23
(Er. C. L. Meena)
Executive Engineer (SD)



नई दिल्ली नगरपालिका परिषद्

NORTHERN RAILWAY



No. 128-W/260/QTN/08/2023-24/W-II
Dated : 06.02.2024

DRM's Office
New Delhi

M/s Sign Xpress India,
RZ-8, Mahendra park,
uttam nagar, East, Delhi-110059

Sub :- Installation/Providing PU TACTILE & BRAILLE SIGNAGE at DSA Station in the section of SSE/W/M/GZB, under ADEN /GZB N.RLY"

D/Sir,

In continuation of your quotation of dated 17.01.2024, in connection with the noted work at the rates shown below have been accepted by the Competent Authority for and on behalf of President of India subject to the terms and conditions as embodied in the tender conditions of the contract and subject to the Northern Railway Engineering Department General Conditions of the Contract Regulations and Instructions for the Tenderer and Standard form of contract, 2018 edition (corrected up to date) and Standard specifications for the material and works 2010 edition (Corrected up to date) and standard schedule of rates 2010 edition (Corrected up to date) and special condition as attached along with quotation.

S.N	Description of Item	Qty
Item No	Description of Items	
1	Providing & fixing PU Tactile tile 01 (DIRECTIONAL) Dimension: 300x300x7.3 mm Fixing: Self-adhesive tape including all taxes, charges, all L&M, T&P as a complete job. Nothing extra will be paid whatsoever the case may be.	10.50
2	Providing & fixing PU Tactile tile TILE 02 (WARNING) Dimension: 300x300x7.3 mm Fixing: Self-adhesive Tape including all taxes, charges, all L&M, T&P as a complete job. Nothing extra will be paid whatsoever the case may be.	90
3	Providing & fixing braille signage acrylic material: 3mm acrylic sheet matt of standard sizes: 200X200, 200X150, 300X150, 450X450 (MM) including all taxes, charges, all L&M, T& as a complete job. Nothing extra will be paid whatsoever the case may be.	0.7
4	Providing & fixing braille signage stainless steel material: 0.5 stainless steel 304 grade of standard sizes: 200X200, 200X150, 300X150, 450X450, 200X50 (MM) including all taxes, charges, all L&M, T&P as a complete job. Nothing extra will be paid whatsoever the case may be.	0.2
5	Providing & fixing antiskid tape for staircase Yellow Reflective Tape: 25mm, Black Anti-skid Tape: 25+25mm, Yellow Retro Reflective Tape: 50mm including all taxes, charges, all L&M, T&P as a complete job. Nothing extra will be paid whatsoever the	50
6	Providing & ixing talking braille signage acrylic material: 3mm acrylic sheet matt of standard sizes: 200X200, 200X150, 300X150, 450X450 MM including all taxes, charges, all L&M, T&P as a complete job. Nothing extra will be paid whatsoever the case may be.	0.25

- Offered rates shall be considered to be included of all taxes, octroi, cost of fuel, labour, T&P machinery, vehicles, lift ascent, descent GST etc. No claim on any account will be made except payment of accepted rates only.
- Please report to ADEN/GZB for taking further instruction for starting the work immediately, completion of this work will be 10 Days from the acceptance of the quotation. The cost of the work is Rs. 496090.75

Handwritten signature
2/2/24
Sr. Divisional Engineer-II
N. Rly., New Delhi
State Entry Road, NDL

Copy to:- ADEN/GZB for information and necessary action please.



MANUFACTURING

In-house all inclusive



Tool Room



Molds & Moldings



VMC Machines



Pack & Dispatch



FAST PROCESS



SUPREME QUALITY



ACCURACY

Signxpress India produces 10,000 PU Tactile tiles daily, ensuring efficient manufacturing to meet accessibility needs and enhance safety for visually impaired individuals nationwide.

The Delhi Division is headed by Divisional Railway Manager (DRM), Serving Haryana, Punjab, Delhi and Uttar Pradesh, The Delhi Division has a route kilometerage of 1386.82 with 213 stations.

Signxpress India offers to provide and Fixing high-quality PU Tactiles tiles to all the DRM Railway Station Platforms.

We are ready to replace all the basic Signs with Accessible Braille Signs with your Initiative.



दिव्यांगजन लोगों का समर्थन करने के लिए एकजुट होने से अर्थपूर्ण परिवर्तन हो सकता है। साथ मिलकर, हम बाधाओं को तोड़ सकते हैं, समावेश को बढ़ावा दे सकते हैं और सभी के लिए समान अवसर सुनिश्चित कर सकते हैं।

*Thank
you*





INNOVATIVE SAFETY SIGNAGES

FULLY CUSTOMIZED

[@signxpressindia.com](https://www.signxpressindia.com)



RETRO REFLECTIVE SIGN BOARD



MANDATORY/REGULATORY SIGNS



CAUTIONARY/WARNING SIGNS



INFORMATORY/GUIDE SIGNS



OVERHEAD GANTRY AND CANTILEVER SIGN BOARD



PROJECTS SIGN BOARDS



HAZARD MARKER AND CHEVRON SIGN BOARD



ROAD SIGNS

ROAD SIGNS CONFORMING TO IRC

(a)

MANDATORY SIGNS

- STOP
- ONE WAY
- NO ENTRY
- ← ONE WAY →
- VEHICLES PROHIBITED IN BOTH DIRECTIONS
- ALL MOTOR VEHICLES PROHIBITED
- TRUCKS PROHIBITED
- BULLOCK CART & HAND CART PROHIBITED
- CYCLE PROHIBITED
- PEDESTRIAN PROHIBITED
- RIGHT TURN PROHIBITED
- LEFT TURN PROHIBITED
- U TURN PROHIBITED
- OVER TAKING PROHIBITED
- BULLOCK CART PROHIBITED
- TONGA PROHIBITED
- HAND CART PROHIBITED
- LENGTH LIMIT
- LOAD LIMIT
- AXLE LOAD LIMIT
- 50 SPEED LIMIT
- 2m WIDTH LIMIT
- 3.5m HEIGHT LIMIT
- HORN PROHIBITED
- NO PARKING
- NO STOPPING
- RESTRICT ON ENDS
- COMPULSORY TURN LEFT
- COMPULSORY AHEAD ONLY
- COMPULSORY TURN RIGHT
- COMPULSORY AHEAD (STRAIGHT)
- COMPULSORY AHEAD (RIGHT TURN)
- COMPULSORY KEEP LEFT
- COMPULSORY CYCLE TRACK
- COMPULSORY SOUND HORN



(b)

CAUTIONARY WARNING SIGNS

- RIGHT HAND CURVE
- LEFT HAND CURVE
- RIGHT HAND BEND
- LEFT HAND BEND
- RIGHT REVERSE BEND
- LEFT REVERSE BEND
- STEEP DESCENT
- STEEP ASCENT
- CYCLE CROSSING
- PEDESTRIAN CROSSING
- SCHOOL
- CATTLE
- FALLING ROCKS
- FERRY
- NARROW ROAD AHEAD
- ROAD WIDENS A-HEAD
- NARROW BRIDGE
- SLIPPERY ROAD
- WEN AT WORK
- DUAL CARRIAGE WAY ENDS
- STAGGERED INTERSECTIONS
- CROSS ROAD
- GAP IN MEDIAN
- LEFT SIDE ROAD
- RIGHT SIDE ROAD
- Y-INTERSECTION
- HORSES
- MAJOR ROAD AHEAD
- ROUND ABOUT
- DANGEROUS OP
- HUMP OR ROUGH ROAD
- BARRIER AHEAD
- T-INTERSECTION
- SPEED BREAKER
- GUARDED RLY CROSSING
- UNGUARDED RLY CROSSING



(c)

FACILITY INFORMATION SIGNS

- ADVISE DIRECTION SIGN
- Delhi (Directional)
- 1 Km PUBLIC TELEPHONE
- PETROL PUMP
- HOSPITAL
- FIRST-AID POST
- MARK THIS SIDE
- MARKS BOTH SIDES
- 3000FT & ABOVE (HILL SIGN)
- ROADWAY GRADE
- RESTRICTION SIGN
- SIDE ROAD
- EATING PLACE
- REFRESHMENT
- PLACE
- ROAD
- CYCLE STAND
- WATER TAP
- ODD TRUCKWAY STAND
- FLUID GAUGE



- Unguarded Rly. Crossing
- Hump Warning Sign
- Manned Level Crossing
- Stop Indicator
- Stop
- Speed Limit Indicator
- Whistle Indicator
- Termination Indicator
- Caution Indicator

- Warning for Goods Train
- Warning for Goods Train
- SHUNTING LIMIT

AIRPORTS AUTHORITY OF INDIA





RETRO REFLECTIVE SIGN BOARD

REFLECTIVE SIGNAGE 157

REF-SIGN-EGP-UB-157



Dimensions : AS PER IRC / NHAJ
Base : 3 mm ACP
Tape : EGP-UNBRANDED

REFLECTIVE SIGNAGE 158

REF-SIGN-EGP-158
EGP



Dimensions : AS PER IRC / NHAJ
Base : 3 mm ACP
Tape : EGP

REFLECTIVE SIGNAGE 159

REF-SIGN-HIP-IV-159
HIP TYPE-IV



Dimensions : AS PER IRC / NHAJ
Base : 3 mm ACP
Tape : HIP TYPE-IV

REFLECTIVE SIGNAGE 160

REF-SIGN-DG-XI-160
HIP TYPE-XI



Dimensions : AS PER IRC / NHAJ
Base : 3 mm ACP
Tape : DG TYPE-XI

STAINLESS STEEL MS SIGN BOARD FRAME WORKS

MS FRAME WORK 161

MS-FRAME-161



Dimensions : 25 mm & 35 mm
Enamel Paint : YES
Sizes : As Per IRC / NHAJ

SS FRAME WORK 162

SS-FRAME-162



Dimensions : 50 (OD) TO 100 (OD)
Finish : Gloss and Matt (SS304)
Sizes : As Per IRC / NHAJ

Sizes of Signs

Signs	Shape	Normal Size (mm)	Small Size (mm)
Mandatory			
i) Stop Sign	Octagonal	900	600
ii) Give way sign (Inverted)	Equilateral triangle	900	600
ii) Others	Circular	600	400
Warning	Equilateral Triangle	900	600
Informatory	Rectangle	800x600	600x450

Specifications

Substrate :	2mm thick Aluminium Sheet with degreasing treatment & fine grinding on front side for proper pasting of Reflective sheet & degreasing treatment & stove enamel paint on backside. or 3mm thick ACP (Aluminium Composite Panel)
Reflective Material	* Engineering Grade/Safety Grade * High Intensity Grade (Encapsulated Lens type) * High Intensity Prismatic HIP * Micro prismatic Lens (Diamond Grade/OMNI Grade Type VIII & IX)
Symbols/Messages / Lettering/Border:	Screen Printed/Cut-outs.

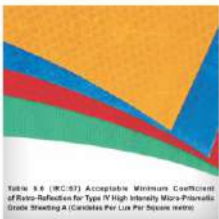

HIP TYPE IV

Code : HIP Type-IV
Colours : White, Yellow, Red, Orange, Blue, Green
Service Life : 7+ Years (ASTM D4956)



DIAMOND GRADE DG TYPE XI

Code : Diamond Grade DG Type-XI
Colours : White, Yellow, Red, Blue, Green, Fluorescent Yellow, Yellow Green, Orange
Service Life : 10+ Years (ASTM D4956)



ELECTROCUT FILM (ECF)

Code : ECF
Colours : Yellow, Red, Orange, Blue, Green, Black, Brown
Dimensions : 1.22 m x 45.7 m



HIGH QUALITY RETRO REFLECTIVE PRINTING

Code : HIP PRINT
Colours : White, Yellow, Red, Blue, Green, Fluorescent Yellow, Yellow Green, Orange
Service Life : 10+ Years (ASTM D4956)

NEW ARRIVAL

EMERGENCY LED SIGN BOARD

EMERGENCY LED SIGNAGE 152-153

LED-SIGN-EXT-SS-152
LED-SIGN-EXT-DS-153



Fully Customized Available in



Dimensions : 300 X 150 mm
Battery Backup : 120 minutes
Design X Colour : Customized

Self Contained Rechargeable Emergency

- ▲ Battery Duration + 10%
- ▲ Aluminium Housing Body
- ▲ Input 230V, 50Hz (other available)
- ▲ Supply- Also Available 24V DC.
- ▲ Also Available With Different Colours LED
- ▲ Also Available With Higher Backup

MALLS, OFFICES, HOSPITALS, SCHOOL, PARKING, HOTELS, RAILWAYS, AIRPORTS

Maintained

LED

2 hrs. Backup



F 01



F 02



F 03



F 04



F 05



F 06



F 07



F 08



F 09



F 10

SAFETY SIGNAGE 154-155-156

GID-SIGN-154 (3mm Sun Board)
GID-SIGN-155 (3mm Acrylic)
GID-SIGN-156 (3mm ACP)

BEST PRICE

DAY TIME



NIGHT TIME



SignXpress India's glow-in-the-dark safety signage offers high visibility in Low-light conditions, enhancing safety and awareness in various environments.

In case of fire

DO NOT use lift

Use the stairs

ESCAPE PLAN

DIRECTION DS 1 SIZE 150 x 150mm 200 x 200mm

SAFETY SS 1 SIZE 100 x 100mm 200 x 100mm

PROHIBITION PS 1 SIZE 100 x 100mm 200 x 200mm

FIRE SIGN FS 1 SIZE 100 x 100mm 200 x 200mm

MANDATORY MS 1 SIZE 100 x 150mm 200 x 200mm

WARNING WS 1 SIZE 150 x 150mm 200 x 200mm

COMBINE CS 1 SIZE 200 x 200mm 275 x 250mm



SPEED BREAKERS

RUBBER SPEED BREAKER 163

RSB-163



Dimensions : 500x350x50 (mm)
Weight per meter : 16 kg
Nails/Hardware : Extra

RUBBER SPEED BREAKER 164

RSB-164



Dimensions : 500x415x50 (mm)
Weight per meter : 17 kg
Nails/Hardware : Extra

RUBBER SPEED BREAKER 165

RSB-165



Dimensions : 500x350x75 (mm)
Weight per meter : 27 kg
Nails/Hardware : Extra

RUBBER SPEED BREAKER 166

RSB-166



Dimensions : 500x425x75 (mm)
Weight per meter : 26 kg
Nails/Hardware : Extra

RUBBER SPEED BREAKER 167

RSB-167



Dimensions : 250x350x50 (mm)
Weight per meter : 16 kg
Nails/Hardware : Extra

RUBBER RUMBLER STRIPS 168

RRS-168



Dimensions : 500x125x25 (mm)
Weight per meter : 3 kg
Nails/Hardware : Extra

PLASTIC SPEED BREAKER 169

PSB-169



Dimensions : 250x350x50 (mm)
Weight per meter : 3.8 kg
Nails/Hardware : Extra

POLY SPEED BREAKER 170

PSB-170



Dimensions : 250x350x50 (mm)
Weight per meter : 3.8 kg
Nails/Hardware : Extra

HIGHWAY SPEED BREAKER 171

PSB-171



SPECIAL FOR HIGHWAY ROADS

Dimensions : 250x350x50 (mm)
Weight per meter : 11 kg
Nails/Hardware : Extra

PLASTIC SPEED BREAKER 172

PSB-172



Dimensions : 500x425x75 (mm)
Weight per meter : 3.5 kg
Nails/Hardware : Extra

PLASTIC SPEED BREAKER 173

PSB-173



Dimensions : 750x250x75 (mm)
Weight per meter : 8 kg
Nails/Hardware : Extra

PLASTIC RUMBLER STRIPS 174

PSB-174



Dimensions : 500x130x25 (mm)
Weight per meter : 2 kg
Nails/Hardware : Extra

CORNER GUARD U 175

RCG-175

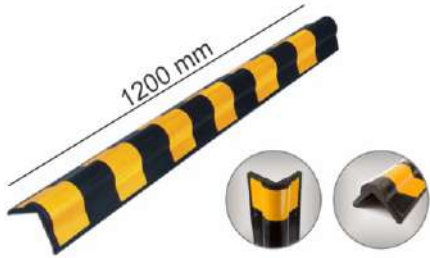

Dimensions : 1200x100x100x15 (mm)
 Weight : 4.15 kg
 Screw/Hardware : Extra

CORNER GUARD U 176

RCG-176



Dimensions : 900x100x100x25 (mm)
 Weight : 3.25 kg
 Screw/Hardware : Extra

CORNER GUARD U 177

RCG-177



Dimensions : 1000x100x100x15 (mm)
 Weight : 3.25kg
 Screw/Hardware : Extra

CORNER GUARD L 178

RCG-178



Dimensions : 1000x100x100x12 (mm)
 Weight : 3.18 kg
 Screw/Hardware : Extra

CORNER GUARD L 179

RCG-179

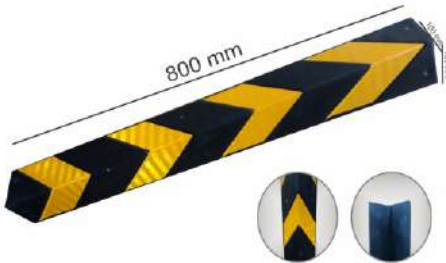

Dimensions : 800x100x100x8 (mm)
 Weight : 1.8 kg
 Screw/Hardware : Extra

WALL GUARD 180

RWG-180

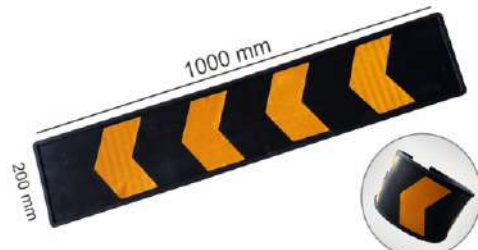

Dimensions : 1000x100x100x15 (mm)
 Weight : 3 kg
 Screw/Hardware : Extra

SAFE YOUR CAR TODAY!





RUBBER WHEEL CHOCK, DOCK BUMPER, WHEEL RAMP

RUBBER WHEEL CHOCK 181

RWC-181



Dimensions : 224x150x113 (mm)
Weight per Piece : 3kg

RUBBER WHEEL CHOCK 182

RWC-182



Dimensions : 250x170x182 (mm)
Weight per Piece : 6kg

RUBBER WHEEL CHOCK 183

RWC-183



Dimensions : 325x200x225 (mm)
Weight per Piece : 11kg

RUBBER PARKING BLOCK 184

RPB-184



Dimensions : 600x120x100 (mm)
Weight per Piece : 3kg
Nails/Hardware : Extra

PLASTIC WHEEL CHOCK 185

PWC-185



Dimensions : 470x230x200 (mm)
Weight per Piece : 3kg



RUBBER DOCK BUMPER R 186

RDB-R-186



Dimensions : 450x250x100 (mm)
Weight per Piece : 11 kg
Nails/Hardware : Extra

RUBBER DOCK BUMPER D 187

RDB-D-187



Dimensions : 500x150x150 (mm)
Weight per Piece : 11 kg
Nails/Hardware : Extra



RUBBER WHEEL RAMP 188

RWRAMP-188



NEW ARRIVAL



Dimensions : 480x320x130 (mm)
Weight : 11 kg



NEW ARRIVAL

SAFETY PRODUCTS

CABLE PROTECTOR 5C 189

RWC-189



Dimensions : 500x470x50 (mm)
Weight per piece : 20kg
Inside Details : 5 Cables x 25 mm

CABLE PROTECTOR 3C 190

RCP-190



Dimensions : 900x460x75 (mm)
Weight per piece : 12 Kg Approx
Inside Details : 3 Cables x 25 mm



EPOXY 191

EPOXY-191



Resin : Part A - 6 Kg Resin
Hardener : Part B - 1 Kg Hardener
Used for : Road Safety Products

CAR WHEEL LOCK 192

CWL-192



Dimension : 480 (H) x 253 (W)
Tyre Size : 35 mm to 275 mm
Material : MS Metal
Weight : 2 Kg Approx



BATON LIGHT 28R 193

BATON-28R-193



Dimensions : 28 cm
Charger : Included
Magnetic base : Yes
Features : Red, Green, Flashing & Torch

BATON LIGHT 52R 194

BATON-52R-194



Dimensions : 52 cm
Charger : Included
Magnetic base : No
Features : Red, Green, Flashing & Torch

BATON LIGHT STOP GO 195

BATON-STOPGO-195



Dimensions : 19 cm Radius
Options : Rechargeable

BATON LIGHT 28B 196

BATON-196



Dimensions : 28 cm
Batteries : Not Included
Magnetic base : Yes
Features : Red, Green, Flashing & Torch

BATON LIGHT 52B 197

BATON-52B-197



Dimensions : 52 cm
Batteries : Not Included
Magnetic base : No
Features : Red, Green, Flashing & Torch



SAFETY PRODUCTS

CONVEX MIRROR 198

CNVX-100-198



Dimensions : 100 cm / 1000 mm / 39 inch
Weight : 5 kg

CONVEX MIRROR 199

CNVX-80-199



Dimensions : 80 cm / 800 mm / 32 inch
Weight : 3 kg



CONVEX MIRROR 200

CNVX-60-200



Dimensions : 60 cm / 600 mm / 24 inch
Weight : 2.5 kg

CONVEX MIRROR 201

CNVX-40-201



Dimensions : 40 cm / 400 mm / 18 inch
Weight : 1.5 kg



SPRING POST DELINEATOR 202

SP-POST-PVC-A
SP-POST-PU-B



Dimension : 750 mm x 200 mm
Weight : 1 Kg Approx
Nails/Hardware : Extra



CAUTION BOARD 203

COTN-BOARD



Dimensions : 750 mm x 1000 x 400 mm
Weight : 1.5 kg Approx



SAFETY PRODUCTS

TRAFFIC CONE 204

CONE-750
CONE-1000



Dimensions : 750 mm x 400 mm (1.5 kg)
1000 mm x 400 mm (4 kg)

TRAFFIC CONE 205

CONE-LW
CONE-HW



Dimensions : 750 x 380 (mm)
Weight LW : Light Weight 2.5 kg
Weight HW : Heavy Weight 3.5 kg

TRAFFIC CONE HEXAGONAL 206

CONE-HEXA-206



Dimensions : 750 x 430 (mm)
Weight : 3.8 kg

MESSAGE BOARD 207

CONE-MSG-BRD-207



Dimensions : 410 x 360 x 210 (mm)
Message on Board : Customized

PLASTIC LINK CHAIN 208

CHAIN-208



Thickness : 8 (mm)
Length : 10 meter

SAFETY HELMET 209

HLMT-209



JACKET-210

JACKET-210



SIZE : S,M,L,XXL
COLOUR : ORANGE, GREEN

JACKET-211

JACKET-211



SIZE : S,M,L,XXL
COLOUR : ORANGE, GREEN

JACKET-212

JACKET-212



SIZE : S,M,L,XXL
COLOUR : ORANGE, GREEN



RAISED PAVEMENT MARKER - ROAD STUD

ABS ROAD STUD 219

ABS-RPM-M-3M-ILC-219

3M



Colours : Red / White / Yellow / Red+White
Dimension : 100x90x18 mm
Direction : Two way prismatic reflector

ABS ROAD STUD 220

ABS-RPM-3M-IS-220

3M



Colours : Red / White / Yellow / Red+White
Dimension : 100x90x18 mm
Direction : Two way prismatic reflector

ABS ROAD STUD 221

ABS-RPM-3M-TMDS-221

3M



Colours : Red / White / Yellow / Red+White
Dimension : 100x90x18 mm
Direction : Two way prismatic reflector

ABS ROAD STUD 222

RPM-ABS-222

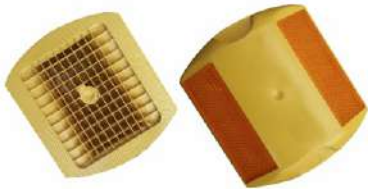

Colours : Red / White / Yellow / Red+White
Dimension : 100x90x18 mm
Direction : Two way prismatic reflector

ABS ROAD STUD 223

RPM-TMDS-223

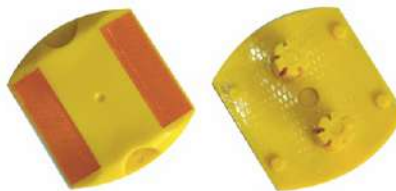

Colours : Red / White / Yellow / Red+White
Dimension : 100x90x18 mm
Direction : Two way prismatic reflector

ABS ROAD STUD 224

RPM-SQR-224



Colours : Red / White / Yellow / Red+White
Dimension : 100x100x20 mm
Direction : Two way prismatic reflector

ABS ROAD STUD 225

ABS-RPM-NG-225



Colours : Red / White / Yellow / Red+White
Dimension : 100x100x20 mm
Direction : Two way prismatic reflector

ABS ROAD STUD 226

ABS-RPM-NG-226



Colours : Red / White / Yellow / Red+White
Dimension : 100x100x20 mm
Direction : Two way prismatic reflector

ABS ROAD STUD 227

ABS-RPM-NG-227



Colours : Red / White / Yellow / Red+White
Dimension : 100x90x18 mm
Direction : Two way prismatic reflector

ABS ROAD STUD 228

ABS-RPM-NG-228



Colours : Red / White / Yellow / Red+White
Dimension : 100x90x18 mm
Direction : Two way prismatic reflector



SOLAR ROAD STUD - ROAD FURNITURE

SOLOR ROAD STUD 229

SOL-STD-229

1 year warranty



Dimensions : 125X125X25 (mm)
 IPS 68 : Yes
 Load Capacity : 20 Tons

SOLOR ROAD STUD-SI 230

SOL-STD-230

1 year warranty



Dimensions : 125X125X25 (mm)
 IPS 68 : Yes
 Load Capacity : 20 Tons

SOLOR ROAD STUD NG 231

SOL-STD-NG-231

1 year warranty



Dimensions : 125X125X25 (mm)
 IPS 68 : Yes
 Load Capacity : 20 Tons

SOLOR ROAD STUD NG ABS 232

ABS-SOLAR-232

1 year warranty



Dimensions : 360 degree
 IPS 68 : Yes
 Load Capacity : 20 Tons

ALUMINIUM ROAD STUD 233

AL-RPM-233



Features : Two way prismatic reflector
 Dimension : 110x100x20 mm
 Fixing : With Shank / Nail

ALUMINIUM ROAD STUD 234

AL-RPM-234



Features : Two way 43 Glass Beads
 Dimension : 110x100x20 mm
 Fixing : With Shank / Nail

ALUMINIUM ROAD STUD 235

AL-RPM-235



Features : Two Way 21 Glass Beads
 Colours : Red / Whit / Yellow / Red+White
 Dimension : 100x100x20 mm
 Fixing : With Shank / Nails

ALUMINIUM ROAD STUD 236

AL-RPM-236



Features : Two way prismatic reflector
 Dimension : 100x100x20 mm
 Fixing : With Shank

ALUMINIUM ROAD STUD 237

AL-RPM-569-TORTOISE-237



Features : Two way 21 Glass Beads (7x3)
 Dimension : 100x75x20 mm
 Fixing : With Nail

GUARD RAIL REFLECTORS 238

GRR-238

Tape Using



Material : GI metal sheet
 Reflective : HIP Type-IV, DG Type-XI, Type-I
 Features : Guard Rail Medians

GUARD RAIL REFLECTORS 239

GRR-239

With Custom Logo



Tape : Flourescent Type-IV HIP
 Reflective Sheeting
 Reflection : Both Side Reflective
 Material : Thermoplastic Body

MEDIAN MARKER PLASTIC 240

3M-FMM-240



Tape : Flourescent Type-XI DG-3
 Reflective Sheeting
 Reflection : Both Side Reflective
 Features : Full Flexible

SAFETY TAPES

ANTI-SKID TAPE 213

ASKD-TAPE-25
ASKD-TAPE-50



Width : 25 mm & 50 mm
Length : 18m
Colours : Yellow, Black, Yellow-Black

FLOOR MARKING TAPE 214

FM-TAPE-214



Width : 50 mm (Customized)
Length : 18 meter

RETRO REFLECTIVE TAPE 215

REF-TAPE-215



Width : 50 mm
Length : 45 meter

GLOW-IN-DARK TAPE 216

GID-TAPE-216



Width : 25 mm & 50 mm (Customized)
Length : 18 meter
Custom Logo Print : Yes, Available

CAUTION TAPE 217

COTN-TAPE-217



Width : 75 mm
Length : 200 meter

REFLECTIVE TAPE 218

FM-REF-TAPE-218



Width : 50 mm
Length : 45 meter

CONSPICUITY TAPE 3M 50MM

REF-TAPE

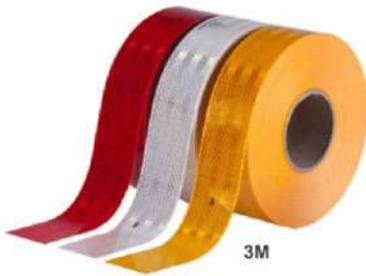

Width : 50 mm
Length : 50 meter

3M

ANTI-SKID 3M 50MM

ASKD-TAPE-50



Width : 25 mm & 50 mm
Length : 18m
Colours : Yellow, Black, Yellow-Black

3M

ANTI-SKID + REFLECTIVE 50MM



Width : 50 mm
Length : 18m
Colours : Yellow-Black



ROAD SAFETY PRODUCTS

WARNING REFLECTOR 241

WARING-REFL-241



Dimension : 165 x 165 x 165 mm Triangle
 Colour : Red
 Weight : 72 g
 Best for : Auto / Truck / Bus / Tractor

**EXCLUSIVE
 RANGE !!**

BEST PRICE! GUARANTEED!

SAFETY FIRST!

Get a free quote today.

SOLAR DELINEATOR 242

SOL-DEL-CLAMP-242



Features : 74 times flashing per minute
 Colours : Red
 Dimension : H-150 mm, Dia-90 mm
 Voltage : 1.2 Volts, 1200mAH
 Panel : 2.5 Volts 120mA

TRAFFIC SOLAR BLINKER 243

SOLBLINK-243



Solar Cell: 15W [Type: Mono Crystalline, Voltage: 18V/900mA]
 Battery Type: Plumbic Acid [Voltage: 12V]
 LED: Size: 5 mm - 172 LED, or as required.
 luminous intensity: 8000 - 9000 mcd.
 iC frequency: 38-40/minute.
 Operating Time: Sustain Power Supply continuously for over 4 days when in the wet or rainy days after full-charging.
 Temperature Range: -20 °C to + 70 °C.
 Warranty years: 1 year.
 Service Life: Over 3 years if used in an efficient way.
 Application: Dangerous Roads.
 Material: pC plastic anti-uv material.



Q-MANGER GOLDEN 244

QMR-SS-GOLD



Material : SS 202
 Weight : 8.5 kg
 Custom Logo : Yes Available

Q-MANGER SILVER 245

QMR-SS-SLIVER-A
 QMR-SS-SLIVER-B

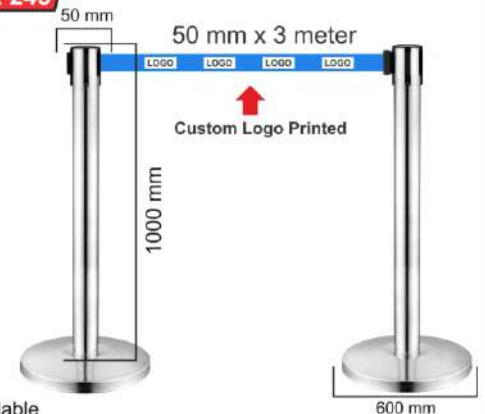

Material : SS 202
 Weight : 8 kg
 Custom Logo : Yes Available

SIGN XPRESS INDIA
 SIGN FOR LIFE

Best Solution for Long Queues



DELINEATORS

DELINEATOR 3M IRC 246

DEL-IRC-3M-246



1000

Height : 1000 mm
Width : 100 mm
Weight : 2.5 Kg Approx
Tape : 3M Type-XI



DELINEATOR IRC 247

DEL-IRC-247



1000

Height : 1000 mm
Width : 100 mm
Weight : 2.5 Kg Approx
Tape : EGP, Type-IV, Type-XI



DELINEATOR WITH JAALI 248

DEL-MS-JAALI-248



Height : 750, 1000, 1200 mm
Pipe Dia : 48 mm, 65 mm, 85 mm, 100 mm
Jaali : MS Jaali with Powder Coating
Tape : HIP, EGP, Radium Tape

DELINEATOR 480D YELLOW 249

DEL-REF-249



Height : 750 mm / 1000 mm / 1200 mm
Dia : 48 mm Outer Dia
Reflectors : 2 Way Acrylic Prismatic Reflector
Colours : Yellow & Orange

DELINEATOR 650D YELLOW 250

DEL-REF-250



Height : 750 mm / 1000 mm / 1200 mm
Dia : 65 mm Outer Dia
Reflectors : 2 Way Acrylic Prismatic Reflector
Colours : Yellow & Orange

DELINEATOR SOLAR 251

DEL-SOLAR-251

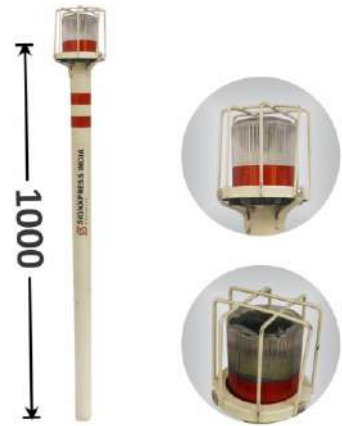

1000

Height : 1000 mm
Dia : 48 mm Outer Dia
Reflectors : 74 flash/per/minute
Voltage : 1.2 V, 1200mAH

MS BOLLARD 252

BLRD-252



800

Height : 800 mm
Dia : 90 mm
Base Plate : 175 mm
Reflective : 75 mm x 2 bends of HIP
Weight : 4.5 kg Approx

MS BOLLARD 253

BLRD-253



750

Height : 750 mm
Dia : 90 mm
Base Plate : 175 mm
Reflective : 25 mm x 4 bends of HIP
Weight : 4 kg Approx

MS BOLLARD 254

BLRD-254



800

Height : 800 mm
Dia : 90 mm
Base Plate : 175 mm
Reflective : 25 mm x 4 bends of HIP
Weight : 4 kg Approx

SIGNXPRESS INDIA
ROAD MARKING PAINT



Design, production and construction of one-stop service



High Quality

Thermoplastic Road Marking By Signxpress India

- 1 City & Highway Roads**
- 2 Airport Runway**
- 3 Cycle Track**
- 4 Divyangjan Parking**
- 5 Warehouse & Parking Lot**

ROAD MARKING PAINT 255

SKU: SI-RM-PAINT-255

Quality : As per MORT&H, NHAI, CPWD, PWD, or as per requirements
 Colour : : White, Yellow, Green, Blue, Red, Orange and all approved colour are available
 Packing : 25 kg Bag
 Self Life : 9-12 Months
 Delivery : Pan India Delivery

MRP: BASIC 120/- PER KG
 MRP: BS GRADE 180/- PER KG
 MRP: MORT&H GRADE 240/- PER KG



MSME-UDYAM

11/02/2023 09:08 PM Print: Udyam Registration Certificate

सरकार भारत
Government of India
उद्यम, सूक्ष्म एवं मध्यम उद्यम विभाग
Ministry of Micro, Small and Medium Enterprises

UDYAM
REGISTRATION CERTIFICATE

Our small hands to make you LARGE

UDYAM REGISTRATION NUMBER	UDYAM-DL-06-00250																																																							
NAME OF ENTERPRISE	SIGNXPRESS INDIA																																																							
TYPE OF ENTERPRISE	MICRO (Based on FY 2020-21) (MICRO Based on FY 2019-20)																																																							
STATUS OF STATUS	MANUFACTURING																																																							
SOCIAL CATEGORY OF ENTERPRISE	GENERAL																																																							
NAME OF SMITH	S.No. of Udyam Registration Link to Form 1. REGISTRAR REGISTRATION																																																							
OFFICIAL ADDRESS OF ENTERPRISE	<table border="1" style="width: 100%; border-collapse: collapse;"> <tr> <td>Plot/Block No.</td> <td>C-1B, 3rd Floor</td> <td>Name of Premises/Building</td> <td>SIGNXPRESS INDIA</td> </tr> <tr> <td>Post/Office</td> <td>Uttam Nagar East</td> <td>Pin Code</td> <td>110028</td> </tr> <tr> <td>Block/Neighbourhood</td> <td>3rd Floor</td> <td>City</td> <td>DELHI</td> </tr> <tr> <td>State</td> <td>DL</td> <td>District</td> <td>NORTH WEST DELHI</td> </tr> <tr> <td>Mobile</td> <td>980600107</td> <td>E-mail</td> <td>udamregistration@msme.gov.in</td> </tr> </table>	Plot/Block No.	C-1B, 3rd Floor	Name of Premises/Building	SIGNXPRESS INDIA	Post/Office	Uttam Nagar East	Pin Code	110028	Block/Neighbourhood	3rd Floor	City	DELHI	State	DL	District	NORTH WEST DELHI	Mobile	980600107	E-mail	udamregistration@msme.gov.in																																			
Plot/Block No.	C-1B, 3rd Floor	Name of Premises/Building	SIGNXPRESS INDIA																																																					
Post/Office	Uttam Nagar East	Pin Code	110028																																																					
Block/Neighbourhood	3rd Floor	City	DELHI																																																					
State	DL	District	NORTH WEST DELHI																																																					
Mobile	980600107	E-mail	udamregistration@msme.gov.in																																																					
DATE OF COMMERCIAL REGISTRATION OF ENTERPRISE	03/01/2012																																																							
CITY OF COMMENCEMENT OF INDUSTRIAL BUSINESS	DELHI																																																							
NATIONAL INDUSTRY CLASSIFICATION CODES	<table border="1" style="width: 100%; border-collapse: collapse;"> <tr> <th>S.No.</th> <th>NIC 4 Digit</th> <th>NIC 5 Digit</th> <th>NIC 6 Digit</th> <th>Activity</th> </tr> <tr> <td>1</td> <td>35</td> <td>352</td> <td>3520</td> <td>Wholesaling and retailing of food, beverages and tobacco products</td> </tr> <tr> <td>2</td> <td>35</td> <td>352</td> <td>3529</td> <td>Wholesaling and retailing of other goods</td> </tr> <tr> <td>3</td> <td>35</td> <td>352</td> <td>3529</td> <td>Wholesaling and retailing of other goods</td> </tr> <tr> <td>4</td> <td>35</td> <td>352</td> <td>3529</td> <td>Wholesaling and retailing of other goods</td> </tr> <tr> <td>5</td> <td>35</td> <td>352</td> <td>3529</td> <td>Wholesaling and retailing of other goods</td> </tr> <tr> <td>6</td> <td>35</td> <td>352</td> <td>3529</td> <td>Wholesaling and retailing of other goods</td> </tr> <tr> <td>7</td> <td>35</td> <td>352</td> <td>3529</td> <td>Wholesaling and retailing of other goods</td> </tr> <tr> <td>8</td> <td>35</td> <td>352</td> <td>3529</td> <td>Wholesaling and retailing of other goods</td> </tr> <tr> <td>9</td> <td>35</td> <td>352</td> <td>3529</td> <td>Wholesaling and retailing of other goods</td> </tr> <tr> <td>10</td> <td>35</td> <td>352</td> <td>3529</td> <td>Wholesaling and retailing of other goods</td> </tr> </table>	S.No.	NIC 4 Digit	NIC 5 Digit	NIC 6 Digit	Activity	1	35	352	3520	Wholesaling and retailing of food, beverages and tobacco products	2	35	352	3529	Wholesaling and retailing of other goods	3	35	352	3529	Wholesaling and retailing of other goods	4	35	352	3529	Wholesaling and retailing of other goods	5	35	352	3529	Wholesaling and retailing of other goods	6	35	352	3529	Wholesaling and retailing of other goods	7	35	352	3529	Wholesaling and retailing of other goods	8	35	352	3529	Wholesaling and retailing of other goods	9	35	352	3529	Wholesaling and retailing of other goods	10	35	352	3529	Wholesaling and retailing of other goods
S.No.	NIC 4 Digit	NIC 5 Digit	NIC 6 Digit	Activity																																																				
1	35	352	3520	Wholesaling and retailing of food, beverages and tobacco products																																																				
2	35	352	3529	Wholesaling and retailing of other goods																																																				
3	35	352	3529	Wholesaling and retailing of other goods																																																				
4	35	352	3529	Wholesaling and retailing of other goods																																																				
5	35	352	3529	Wholesaling and retailing of other goods																																																				
6	35	352	3529	Wholesaling and retailing of other goods																																																				
7	35	352	3529	Wholesaling and retailing of other goods																																																				
8	35	352	3529	Wholesaling and retailing of other goods																																																				
9	35	352	3529	Wholesaling and retailing of other goods																																																				
10	35	352	3529	Wholesaling and retailing of other goods																																																				
DATE OF UDYAM REGISTRATION	13/02/2023																																																							

In case of duplicate registration of status of an enterprise, the benefit of the Government Scheme will be available as per the provision of Sub-Section 5.10.1 (2)(b) dated 20/06/2018 issued by the MoSME.

Disclaimer: This is a system-generated document, no signature required. Printed from <https://udamregistration.gov.in> at 09:08 AM on 13/02/2023.

For any assistance, you may contact:

1. District Industries Centre: DELHI (DELHI)

2. MSME-UD: DELHI (DELHI)

BE A CHAMPION
With the Ministry of

https://udamregistration.gov.in/Udyam_Udyam_MicroApplication.aspx

MSME-UDYOG ADHAAR

उद्योग आधार
Udyog Aadhaar

UDYOG ADHAAR NUMBER	DL0000000000																		
NAME OF ENTERPRISE	SIGNXPRESS INDIA																		
LOCATION OF PLANT DETAILS	<table border="1" style="width: 100%; border-collapse: collapse;"> <tr> <th>Sr.</th> <th>Plot/Block No.</th> <th>Name of Premises/Building</th> <th>Registered Land</th> <th>Area/Locality</th> <th>City</th> <th>Pin</th> <th>State</th> <th>District</th> </tr> <tr> <td>1</td> <td>C-1B</td> <td>SIGNXPRESS</td> <td>3RD FLOOR</td> <td>MAHENDRA PARK, ADARSH NAGAR</td> <td>DELHI</td> <td>110028</td> <td>DELHI</td> <td>NORTH EAST</td> </tr> </table>	Sr.	Plot/Block No.	Name of Premises/Building	Registered Land	Area/Locality	City	Pin	State	District	1	C-1B	SIGNXPRESS	3RD FLOOR	MAHENDRA PARK, ADARSH NAGAR	DELHI	110028	DELHI	NORTH EAST
Sr.	Plot/Block No.	Name of Premises/Building	Registered Land	Area/Locality	City	Pin	State	District											
1	C-1B	SIGNXPRESS	3RD FLOOR	MAHENDRA PARK, ADARSH NAGAR	DELHI	110028	DELHI	NORTH EAST											
OFFICIAL ADDRESS OF ENTERPRISE	<table border="1" style="width: 100%; border-collapse: collapse;"> <tr> <td>F-10 STREET NO.31, MAHENDRA PARK, ADARSH NAGAR,</td> <td>DELHI</td> <td>DELHI</td> <td>110028</td> </tr> <tr> <td>MOBILE No.</td> <td>980600107</td> <td>E-mail</td> <td>udamregistration@msme.gov.in</td> </tr> </table>	F-10 STREET NO.31, MAHENDRA PARK, ADARSH NAGAR,	DELHI	DELHI	110028	MOBILE No.	980600107	E-mail	udamregistration@msme.gov.in										
F-10 STREET NO.31, MAHENDRA PARK, ADARSH NAGAR,	DELHI	DELHI	110028																
MOBILE No.	980600107	E-mail	udamregistration@msme.gov.in																
DATE OF COMMENCEMENT	03/01/2012																		
MAJOR ACTIVITY	SERVICES																		
ENTERPRISE TYPE	Micro																		
PREVIOUS REGISTRATION STATUS (if any)	None																		
INDUSTRIAL CLASSIFICATION CODE	<table border="1" style="width: 100%; border-collapse: collapse;"> <tr> <th>Sr.</th> <th>NIC 2 Digit</th> <th>NIC 3 Digit</th> <th>NIC 4 Digit Code</th> <th>Activity Type</th> </tr> <tr> <td>1</td> <td>35</td> <td>352</td> <td>3520</td> <td>Wholesaling and retailing of food, beverages and tobacco products</td> </tr> <tr> <td>2</td> <td>35</td> <td>352</td> <td>3529</td> <td>Wholesaling and retailing of other goods</td> </tr> </table>	Sr.	NIC 2 Digit	NIC 3 Digit	NIC 4 Digit Code	Activity Type	1	35	352	3520	Wholesaling and retailing of food, beverages and tobacco products	2	35	352	3529	Wholesaling and retailing of other goods			
Sr.	NIC 2 Digit	NIC 3 Digit	NIC 4 Digit Code	Activity Type															
1	35	352	3520	Wholesaling and retailing of food, beverages and tobacco products															
2	35	352	3529	Wholesaling and retailing of other goods															
ACKNOWLEDGEMENT	<table border="1" style="width: 100%; border-collapse: collapse;"> <tr> <td>Date of Filing</td> <td>26/02/2018</td> <td>Date of Printing</td> <td>25/02/2018</td> </tr> </table>	Date of Filing	26/02/2018	Date of Printing	25/02/2018														
Date of Filing	26/02/2018	Date of Printing	25/02/2018																

Disclaimer: This is a system-generated document, no signature required. Printed from udyogadhaar.gov.in

MyAar Mobile App (Beta Version) is available now for download. <https://play.google.com/store/apps/details?id=com.mse.aar>

IMPORT-EXPORT CODE

Government of India
Ministry of Commerce and Industry
Directorate General of Foreign Trade
Office of the Additional Director General of Foreign Trade, CLA Delhi
Central Licensing Area (CLA) Wing I.P. Bhowan, I.P. Estate, New Delhi

Importer-Exporter Code

This is to certify that SIGNXPRESS INDIA is issued an Importer-Exporter Code (IEC) ABKPH462N with details as follows:

IEC	ABKPH462N
आयुक्त संस्थान सं. (पैन) / PAN	ABKPH462N
आयुक्त संस्थान नाम	SIGNXPRESS INDIA
व्यवस्थापन प्रकार / Nature of Concern	Proprietorship
जारी करने की तिथि / Date of Issue	07/05/2022
पता / Registered Address	Shop No. 22, AJB Market, Jank Puri Wost, New Delhi, WEST DELHI, DELHI, 110058
व्यवस्थापक / Name of the Signatory	Honey Chugh
निदेशक / Partner Details	Refer online at https://dgtf.gov.in or scan the QR Code
शाखा/दफ्तर / Branch Details	Refer online at https://dgtf.gov.in or scan the QR Code

Last Modified : 07/05/2022
File Number : DLIECPAPPV00012231AM23

Note : This is a system-generated certificate. Authenticity : Updated details of the IEC can be checked at official DGT website <https://dgtf.gov.in> by entering the IEC and Firm Name under Services > View Any IEC Details. You can also authenticate the certificate by scanning the QR code.

GST

Government of India
Form GST REG-06
(See Rule 10(1))

Registration Certificate

Registration Number : 07ABKPH462N2Z8

1. Legal Name	HONEY CHUGH
2. Trade Name, if any	SIGNXPRESS INDIA
3. Additional trade names, if any	
4. Constitution of Business	Proprietorship
5. Address of Principal Place of Business	RZ-6, MAHENDRA PARK, Uttam Nagar, New Delhi, West Delhi, Delhi, 110059
6. Date of Liability	01/07/2017
7. Date of Validity	From 01/07/2017 To Not Applicable
8. Type of Registration	Regular
9. Particulars of Approving	Delhi Goods and Services Tax Act, 2017

Signature

Name	Chander Shekhar
Designation	Sales Tax Officer Class II / AUATO
Jurisdictional Office	Ward 60
Date of Issue of Certificate	06/11/2023

Note: This registration certificate is required to be prominently displayed at all places of Business/Offices in the State.

This is a system-generated digitally signed Registration Certificate issued based on the approval of application granted on 09/11/2023 by the jurisdictional authority.

ISO 14001:2015

Certificate of Registration
 This is to certify that the Environmental Management System of
SIGNXPRESS INDIA
 C-30, MILAP NAGAR, UTTAM NAGAR EAST METRO STATION,
 NEW DELHI-110059, INDIA
 has been independently assessed by PQC and found to comply with the
 requirements of
(ENVIRONMENTAL MANAGEMENT SYSTEM)
ISO 14 001:2015
 For the following scope:
**MANUFACTURING AND TRADING OF ROAD SAFETY PRODUCTS,
 TRAFFIC SAFETY EQUIPMENT, INDUSTRIAL SAFETY PRODUCTS,
 FIRE SAFETY & ROAD SAFETY SIGNAGE, & ROAD CONSTRUCTIONS
 MATERIAL TESTING INSTRUMENTS**

Certification Calendar:
 Client Id: 8236
 Certificate No: INE/DL/909/0222
 Initial Registered Date: 22.02.2022
 Issuance Date: 22.02.2022
 Date of Expiry: 21.02.2025
 1st Surv. Due: 21.02.2023
 2nd Surv. Due: 21.02.2024

Authorized Signatory

PARAMOUNT QUALITY CERTIFICATIONS
 27, Old Connaught Place, Connaught Place, New Delhi, India

MCD LICENCE

MUNICIPAL CORPORATION OF DELHI
 Central Licensing & Enforcement Cell
 Central Licensing & Enforcement Cell, 21st Floor, Dr.SPM
 Civic Center J.L.Nehru Marg, New Delhi 110002

GENERAL TRADE/STORAGE LICENCE
 सामान्य व्यापार / भंडारण लाइसेंस
RENEW LICENCE

Department विभाग	C/PEC(HQ)	Zone क्षेत्र	WEST ZONE
License No लाइसेंस नंबर	SGT1/922282719	Date of Issue जारी करने की तिथि	27/05/2023
Serial No. सिरी नंबर	417	License valid upto लाइसेंस मान्यता तक	31/03/2024
D.M.C Act के अधिन जारी किया गया	1957		

**Shel./Slat./Sarvahi
 शी /शेल्डी / सराही**
 Register (rol) Mobile Number
 पंजीकृत मोबाइल नंबर
 Type of Firm/
 फर्म का प्रकार
 Relation of Applicant With Company/
 आवेदनकर्ता का संबंध
 Trade Category/
 व्यापार श्रेणी
 Nature of Unit/Trade/Industry/
 प्रकृत / व्यापार का नाम
 Trade Premises Situated /
 व्यापार स्थल स्थिति
 Trade/Storage/
 व्यापार / भंडारण

**Unit area in sq. mtrs/ म²
 वर्ग मीटर में कुल क्षेत्र**
 Recovered Receipt No./ 22909945
 प्राप्त किया गया नंबर

HONEY CHUGHI
 5810052137 (Please contact/ write at above address for
 change of mobile number)
 PROPRIETORSHIP
 PROPRIETOR
 LOCAL COMMERCIAL
 SIGNXPRESS INDIA
 GROUND FLOOR, C-30 MILAP NAGAR EAST UTTAM NAGAR
 DELHI 110059
 WARE HOUSES FROM WHERE GOODS ARE
 SOLD/GOODS/STORAGE/ SHOW ROOMS (SOCIETIES
 WAREHOUSE MALL/PARKING WAH/HOUSE AND ROAD
 SAFETY PRODUCTS)
 License Fees (₹s)/
 लाइसेंस शुल्क (₹)
 License Generated Date/ 27/05/2023
 जन्म तिथि: 27/05/2023

DISCLAIMER
 This license is purely on the basis of documents submitted and self certification. If any of the statements of undertaking is for all intents and purposes forthwith while fortifying the fee and such person shall be liable for legal and penal action for obtaining license fraudulently by making false statements and further more obtaining of license by making false statements in this regard will not amount to permission for change of land use of premises in question.

ISO 23599:2019

Certificate of Compliance
 This is to certify that the products manufactured by
SIGNXPRESS INDIA
 C-30, MILAP NAGAR, UTTAM NAGAR EAST METRO STATION,
 NEW DELHI-110059, INDIA
 has been independently assessed by PQC and found to comply with the
 requirements of
ISO 23599:2019
**(Assistive Products for Blind and Vision-Impaired
 Persons - Tactile Walking Surface Indicators)**

Certification Scope:
**MANUFACTURER & CUSTOMIZATION OF EXPORT QUALITY PRODUCTS-
 DESIGNS: SELF-ADHESIVE POLYURETHANE PU TACTILE TILES-STRIPS-
 STUDS AND BRAILLE SIGNAGE FOR BLIND.**

Certification Calendar:
 Client Id: 11054
 Certificate No: INTW/DL/12750/1122
 Initial Registered Date: 09.11.2022
 Issuance Date: 09.11.2022
 Date of Expiry: 08.11.2025
 1st Surv. Due: 08.11.2023
 2nd Surv. Due: 08.11.2024

Authorized Signatory

PARAMOUNT QUALITY CERTIFICATIONS
 27, Old Connaught Place, Connaught Place, New Delhi, India

ISO 9001:2015

Certificate of Registration
 This is to certify that the Quality Management System of
SIGNXPRESS INDIA
 C-30, MILAP NAGAR, UTTAM NAGAR EAST METRO STATION,
 NEW DELHI-110059, INDIA
 has been independently assessed by PQC and found to comply with the
 requirements of
(QUALITY MANAGEMENT SYSTEM)
ISO 9001:2015
 For the following scope:
**MANUFACTURING AND TRADING OF ROAD SAFETY PRODUCTS,
 TRAFFIC SAFETY EQUIPMENT, INDUSTRIAL SAFETY PRODUCTS,
 FIRE SAFETY & ROAD SAFETY SIGNAGE, & ROAD CONSTRUCTIONS
 MATERIAL TESTING INSTRUMENTS**

Certification Calendar:
 Client Id: 5971
 Certificate No: INQ/DL-6347/0621
 Initial Registered Date: 09.06.2021
 Issuance Date: 09.06.2021
 Date of Expiry: 08.06.2024
 1st Surv. Due: 08.06.2022
 2nd Surv. Due: 08.06.2023

Authorized Signatory

PARAMOUNT QUALITY CERTIFICATIONS
 27, Old Connaught Place, Connaught Place, New Delhi, India



**SIGN
XPRESS
INDIA[®]**
SIGN FOR LIFE

*"Stay tuned for Signexpress India's upcoming products!
From cutting-edge signage to advanced accessibility solutions,
we're revolutionizing safety and communication.
Don't miss out on our latest innovations!"*

Our Respected Clients



"Signxpress India pioneers innovative signage solutions, specializing in road safety and accessibility products. With a focus on quality and reliability, we empower safer, more accessible environments nationwide."

@signxpressindia.com



Corporate Office:

RZ-8 Mahendra Park, Uttam Nagar East,
C1 Janakpuri, New Delhi-110059. (India)

Website:

www.signxpressindia.com
www.signxpressindia.in

GST No:

07ABKPH4628N2Z8

ISO Certifications: ISO: 23599:2019, ISO: 14001:2015, ISO: 9001:2015

Contact:

Landline : (011) 45527272 - (011) 35698644

Sales : (+91) 8882221880

Projects : (+91) 9810032137

Email:

info@signxpressindia.com
connect.signxpressindia@gmail.com

Registered-MSME/MCD:

UDYAM-DL-06-0012360
SGTL0922288719

Feedback & Suggestions:

M: 8512032137



Follow us:

